



**SAMSUNG**

# SPLIT-TYPE AIR CONDITIONER

**INDOOR UNIT**

**OUTDOOR UNIT**

**Model Code:** AR09NXPDPWKNEE  
AR12NXPDPWKNEE

AR09NXPDPWKXEE  
AR12NXPDPWKXEE

**Basic Code:** AR09MSPDPWKNEE  
AR12MSPDPWKNEE

AR09MSPDPWKXEE  
AR12MSPDPWKXEE

# ***SERVICE*** *Manual*

## AIR CONDITIONER

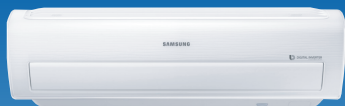

AR09NXPDPWKNEE  
AR12NXPDPWKNEE

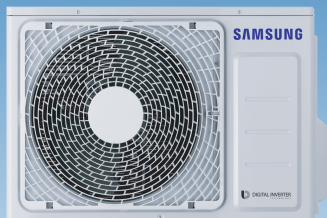

AR09NXPDPWKXEE  
AR12NXPDPWKXEE

## CONTENTS

1. Precautions
2. Product Specifications
3. Alignment and Adjustments
4. Disassembly and Reassembly
5. Assy Control
6. Electrical Parts List
7. Wiring Diagram
8. Schematic Diagram
9. Operating Instructions
10. Troubleshooting
11. Block Diagram
12. Reference Sheet

# Contents

<b>1. Precautions</b> .....	<b>1-1</b>
1-1 Installing the air conditioner.....	1-1
1-2 Power supply and circuit breaker.....	1-1
1-3 During operation .....	1-1
1-4 Disposing of the unit.....	1-2
1-5 Others .....	1-2
<b>2. Product Specifications</b> .....	<b>2-1</b>
2-1 The Feature of Product .....	2-1
2-2 Product Specifications .....	2-2
2-3 The Comparative Specifications of Product.....	2-3
2-4 Accessory and Option Specifications .....	2-4
<b>3. Alignment and Adjustments</b> .....	<b>3-1</b>
3-1 Test Mode.....	3-1
3-2 Display Error and Check Method .....	3-2
3-3 Setting Option Setup Method.....	3-4
<b>4. Disassembly and Reassembly</b> .....	<b>4-1</b>
4-1. Indoor Unit.....	4-2
4-2. Outdoor Unit.....	4-8
4-3. EEPROM DOWNLOAD .....	4-13
<b>5. ASSY CONTROL</b> .....	<b>5-1</b>
5-1 Disassembly WIFI .....	5-1
5-2 ASSY KIT .....	5-2
5-3 ASSY CONTROL OUT .....	5-4
<b>6. Electrical Parts List</b> .....	<b>6-1</b>
6-1 INDOOR MAIN PCB .....	6-1
6-2 OUTDOOR MAIN PBA .....	6-5
<b>7. Wiring Diagram</b> .....	<b>7-1</b>
7-1 Indoor Unit.....	7-1
7-2 Outdoor Unit .....	7-2



# Contents

<b>8. Schematic Diagram</b> .....	<b>8-1</b>
8-1 Indoor Unit.....	8-1
8-2 Outdoor PCB .....	8-2
8-3 Refrigerating cycle diagram .....	8-3
8-4 Indoor PCB .....	8-4
8-4 Outdoor PCB .....	8-5
8-6 Wire connecting the indoor unit terminal blocks.....	8-6
<b>9. Operating Instructions</b> .....	<b>9-1</b>
9-1 Name of Each Part.....	9-1
9-2 Wireless Remote Control-Buttons and Display.....	9-3
<b>10. Troubleshooting</b> .....	<b>10-1</b>
10-1 Items to be checked first.....	10-1
10-2 Communication Error .....	10-2
10-3 PCB Inspection Method.....	10-38
<b>11. Block Diagram</b> .....	<b>11-1</b>
11-1 Indoor unit .....	11-1
11-2 Outdoor unit.....	11-2
<b>12. Reference Sheet</b> .....	<b>12-1</b>
12-1 Index for Model Name .....	12-1
12-2 Low Refrigerant Pressure Distribution.....	12-2
12-3 Pressure & Capacity mark.....	12-3
12-4 Q & A for Non-trouble.....	12-4
12-5 Cleaning /Filter Change .....	12-7
12-6 Installation.....	12-9
12-7 Installation Diagram of Indoor Unit and Outdoor Unit.....	12-10

---

# 1. Precautions

---

## 1-1 Installing the air conditioner

---

- Users should not install the air conditioner by themselves.  
Ask the dealer or authorized company to install the air conditioner except the window-type air conditioner in U.S.A and Canada.
- If you don't install the air conditioner properly, it may cause a fire, a water leakage or an electric shock.
- You must install the air conditioner according to the national wiring regulations and safety regulations.
- Install the indoor unit higher than 2.5m from the floor to avoid the injury caused by the operation of the fan.  
(except the window-type air conditioner)
- The manufacturer is not responsible for any accidents or injury caused by an incorrect installation.
- When installing the built-in type air conditioner, keep all electric cables such as the power cable and the connection cord in pipes, ducts, or cable channels to protect them from the danger of impact or any other incidents.

## 1-2 Power supply and circuit breaker

---

- If the power cord of the air conditioner is damaged, it must be replaced by the manufacturer or a qualified person in order to avoid a hazard.
- The air conditioner must be plugged into an independent circuit if applicable or connect the power cable to the auxiliary circuit breaker.  
An all pole disconnection from the power supply must be incorporated in the fixed wiring with a contact opening of >3mm.
- Do not extend an electric cord to the air conditioner.
- The air conditioner must be plugged in after you complete the installation.

## 1-3 During operation

---

- Do not repair the air conditioner at your discretion.  
It is recommended to contact a service center directly.
- Never spill any kind of liquid on the air conditioner.  
If this happens, turn off the air conditioner and contact an authorized service center.
- Do not insert anything between the airflow blades to prevent damage of the inner fan and consequent injury.  
Keep children away from the air conditioner.
- Do not place any obstacles in front of the air conditioner.
- Do not spray any kind of liquid into the indoor unit. If this happens, turn off the air conditioner and contact a service center.
- Make sure that the air conditioner is well ventilated at all times:  
Do not place a cloth or other materials over it.
- Remove the batteries if you don't use the remote control for a long time. (If applicable)
- Use the remote control within 7 meters from the indoor unit. (If applicable)

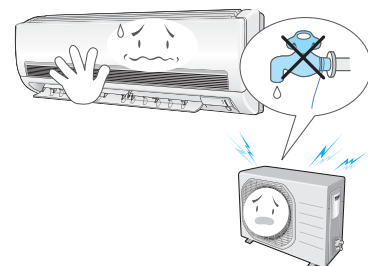

## 1-4 Disposing of the unit

---

- Before the throwing out the air conditioner, remove the batteries from the remote control.
- When you dispose of the air conditioner, consult your dealer. If pipes are removed incorrectly, refrigerant may blow out and cause air pollution. When it contacts with your skin, it can cause skin injury.
- The package of the air conditioner should be recycled or disposed of properly for environmental reasons.

## 1-5 Others

---

- Never store or load the air conditioner upside down or sideways to prevent the damage to the compressor.
- Young children or infirm persons should be always supervised when they use the air conditioner.
- Max current is measured according to IEC standard for safety.
- Current is measured according to ISO standard for energy efficiency.

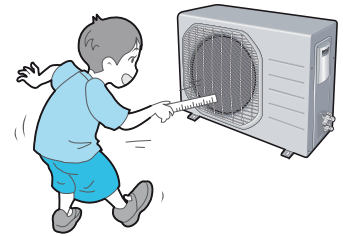

---

## 2. Product Specifications

---

### 2-1 The Feature of Product

---

#### Cool Summer Offer

On those hot sweltering summer days and long restless nights, there is no better escape from the heat than the cool comforts of home. Your new air conditioner brings an end to exhausting hot summer days and lets you rest. Beat the heat with your own air conditioner this summer.

#### Cost Efficient System

Your new air conditioner not only provides maximum cooling power in the summer, but also can be an efficient heating method in the winter with the advanced "Heat pump" system. "Heat pump" system is 3 times more efficient compare to the other electrical heating appliance, so you can further reduce its running cost. Now, meet year-round needs with one air conditioner.

#### Look for Everywhere

The elegant and harmonious design gives priority to the esthetics of your space and complements any of your existing interior décor. With its soft color and rounded-edge shape, the new air conditioner adds class to any room. Enjoy what your air conditioner offers both functionally and esthetically.





#### good'sleep function

good'sleep function allows you to set a comfortable sleep temperature while saving energy and having sound sleep.

## 2-2 Product Specifications







Item			Model	Development Model	Development Model
				AR09NXPDPWK/EE	AR12NXPDPWK/EE
Type				WALL MOUNTED	WALL MOUNTED
Performance	Cooling		W ( Low/ Std/ Max)	900/2500/3400	900/3500/4200
	Heating		W ( Low/ Std/ Max)	800/3200/7100	800/4000/7300
	Noise Level Pressure	Indoor	dB(H/L)	44 / 28	44 / 28
		Outdoor	dB(H/L)	51	53
	EER	Cooling	W/W (Std )	4.63	3.95
		Heating(ISO)	W/W	4.74	4.26
Power		V/Hz/Φ	220-24V/50/1	220-24V/50/1	
Power	PowerConsumption	Cooling(ISO)	W ( Low/ Std/ Max)	180/540/930	180/885/1150
		Heating(ISO)	W ( Low/ Std/ Max)	150/675/2250	150/940/2280
	Operating Current	Cooling(ISO)	A (Std)	2.9	4.1
		Heating(ISO)	A (Std)	3.5	4.4
Size	Outer Dimension	Indoor	W*H*D(mm)	896*261*261	896*261*261
		Outdoor		790*548*285	790*548*285
	Weight(net)	Indoor	Kg	11.8	11.8
		Outdoor		35.0	35.0
	Refrigerant Pipe	Liquid	mm	6.35	6.35
		Gas		9.52	9.52
Drain Hose		D*L(mm)	550*20	550*20	
Heat Exchanger		Indoor	EVAP	Φ7, ( 2R*8S+1R*6S )*705mm, (H1.3+H1.3), N.G.S, 1by2	Φ7, ( 2R*8S+1R*6S )*705mm, (H1.3+H1.3), N.G.S, 1by2
			EVAP Sub	Φ7, ( 2R*6S+1R*4S )*705mm, (H1.3+H1.3), N.G.S : (F04-1)	Φ7, ( 2R*6S+1R*4S )*705mm, (H1.3+H1.3), N.G.S : (F04-1)
		Outdoor	COND	Φ7W, 2R*24S*850/825mm, Corrugate1.5, N.G.S, 4by4by2	Φ7W, 2R*24S*850/825mm, Corrugate1.5, N.G.S, 4by4by2
			COND Sub	Φ7W, 1R*24S*480mm, Corrugate1.5, N.G.S	Φ7W, 1R*24S*480mm, Corrugate1.5, N.G.S
Refrigerant		g	R32, 1050	R32, 1050	
Refrigerant Control Unit			EEV	EEV	
Compressor			KTN130D42UFR	KTN130D42UFR	
Protection device(OLP)			INTERNAL	INTERNAL	
Air purifying system			NEO TRIPLE FILTER	NEO TRIPLE FILTER	
Cooling Operating Condition			-15 ~ 46℃	-15 ~ 46℃	
Heating Operating Condition			-30 ~ 24℃	-30 ~ 24℃	

## 2-3 The Comparative Specifications of Product

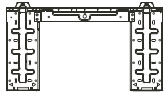
Item	Model	Development Model	Development Model
		AR09NXPDPWK/EE	AR12NXPDPWK/EE
Design	Indoor		
	Outdoor		
Net Weight	Indoor (Kg)	11.8	11.8
	Outdoor(Kg)	35.0	35.0
Outer Dimension (Width x Height x Depth )	Indoor(mm)	896*261*261	896*261*261
	Outdoor(mm)	790*548*285	790*548*285
Noise	Indoor(dB)	44 / 28	44 / 28
	Outdoor(dB)	51	53
Air purifying system	Filter	Neo Triple Filter	Neo Triple Filter

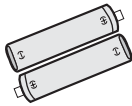
## 2-4 Accessory and Option Specifications

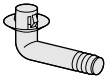
### 2-4-1 Accessories

Item	Descriptions	Code-No.	Q'TY	Remark
	Assy Plate Hanger	DB90-07732A	1	Indoor Unit
	Remote Control	DB93-15883R	1	
	Batteries for Remote Control	4301-000121	2	
	MANUAL USERS MANUAL INSTALL	DB68-07961A DB68-07543A	1 1	
	Drain Plug	DB67-20011A	1	Outdoor Unit
	Rubber Leg	DB67-01533A	4	

---

## 3. Alignment and Adjustments

---

### 3-1 Test Mode

---

#### ■ How to Approach Test Mode

You can approach the Test Mode by pressing the on/off switch of indoor unit for 5 seconds.

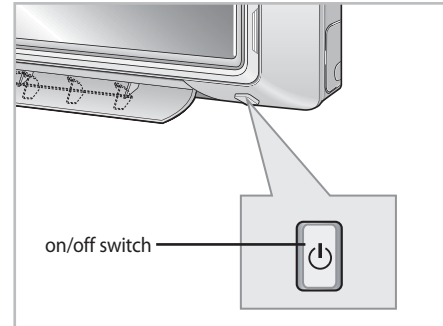

#### ■ Test Mode Operation Option

After installing the air conditioner, check whether each subordinate is normally operated or not by operating the Test Mode.

- **When an error occurs, display the Error Mode.**
- **Operation Mode :** Cool mode. Operate the cool mode by operating the compressor by force without the compressor ON/OFF according to the set temperature/indoor temperature. (Do not follow the antifreeze control)
- **Up-down louver :** Up-down swing mode
- **Indoor Fan :** High



• Because the Test Mode operate the cool mode by force not related to the set temperature / indoor temperature, check whether each subordinate is operated normally or not after completing installation and must turn off the power of the air conditioner.



## 3-2 Display Error and Check Method

### 3-2-1 Indoor Display Error and Check Method

ERROR MODE				DESCRIPTION
7-SEG	LED1	LED2	LED3	
	OPERATION	TIMER	OPTION	
E101,E102	○	◐	◐	Communication error (indoor <-> outdoor)
E121	○	◐	○	ROOM TH sensor error
E122,E123	◐	◐	○	INDOOR MID,INDOOR IN PIPE-TH sensor error
E154	○	○	◐	Fan error(indoor)
E162	◐	◐	◐	EEPROM error
E163	◐	◐	◐	Option error
FROM E200	◐	○	◐	Outdoor error display
E203	◐	●	●	Time out Comm.(Inv Micom <-> Main Micom)
E422/E554	●	○	◐	EEV or Valve Close error-Self diagnosis /Gas Leak Error
E458	●	●	◐	Out door Fan Error
E461	◐	●	◐	Comp Starting Error
E464	○	●	◐	IPM Over Current(O.C) Error
E465	◐	●	○	Comp V_limit/I_limit Error
E500				Heatsink overheat or IPM overheat

● : LAMP ON      ○ : LAMP OFF      ◐ : LAMP BLINK

### 3-2-2 Outdoor LED Display Error and Check Method

LED PATTERN			DESCRIPTION
YEL	GRN	RED	
○	○	○	Power Off / VDD NG
○	◎	●	Normal Operation
○	○	◎	IPM Over Current(O.C)
○	○	●	Abnormal Serial communication (Display Board:Indoor<->Outdoor)
○	◎	○	Comp Starting error
○	●	◎	DC-Link voltage under/over error PFC over load / HW DC_link over
◎	○	◎	Outdoor temp sensor error (Dual/Single)
◎	○	●	Discharge over temperature (Dual/Single)
◎	◎	○	Discharge temp sensor error (Dual/Single)
◎	◎	●	Current sensor error Heatsink sensor error Input current sensor error
◎	●	○	Comp Vlimit error/Heatsink over temp
◎	●	◎	Coil temp sensor error(Dual/Single)
◎	●	●	1min. Time out Comm. (Main <-> Inverter)
●	○	○	Fan error
○	●	○	EEProm data error
●	○	◎	OTP error
●	○	●	Comp wire missing error
●	◎	○	Operation condition secession (Dual only)
●	◎	◎	DC-Link voltage sensor error
●	◎	●	I-Trip error / PFC Over current
●	●	○	GAS Leak error(Dual/Single)
●	●	◎	AC Line Zero Cross Signal out
●	●	●	Power ON reset(1sec)
◎	○	○	capacity miss match
○	◎	◎	Test Operation Cooling Mode
◎	◎	◎	Test Operation Heating Mode

● LED ON    ○ LED OFF    ◎ LED BLINKING

### 3-3 Setting Option Setup Method

ex) Option No. :

Note :



SEG1, SEG7, SEG13, SEG19 need not to be pressed in, so in fact the Option No. we should press in is as below.

30 00 07 C2 6C 83 10 00 00 00 20 00 00 00 00 00 00 10 00 00

SEG1	SEG2	SEG3	SEG4	SEG5	SEG6	SEG7	SEG8	SEG9	SEG10	SEG11	SEG12	SEG13	SEG14	SEG15	SEG16	SEG17	SEG18	SEG19	SEG20	SEG21	SEG22	SEG23	SEG24
0	3	0	0	0	0	1	7	C	2	6	C	2	8	3	1	0	0	3	0	0	0	0	0
SEG25	SEG26	SEG27	SEG28	SEG29	SEG30	SEG31	SEG32	SEG33	SEG34	SEG35	SEG36	SEG37	SEG38	SEG39	SEG40	SEG41	SEG42	SEG43	SEG44	SEG45	SEG46	SEG47	SEG48
0	2	0	0	0	0	1	0	0	0	0	0	2	0	0	0	0	1	3	0	0	0	0	0

#### Step 1





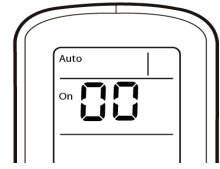



















Enter the Option Setup mode.















1. Tack out the batteries of remote control.
2. Press the temperature  button simultaneously and insert the battery again.
3. Make sure the remote control display shown as .



#### Step 2

Enter the Options Setup mode and select your options according to the following procedure.

	Feature	Display
	<b>1</b> The default value is  . Every time you push the  button, the display panel reads <b>ON</b> Auto → Cool → Dry → Fan → Heat, <b>OFF</b> Auto → Cool → Dry → Fan → Heat repeatedly.	
	<b>2</b> Push the  button to set the display panel to <b>3</b> . Every time you push the  button, the display panel reads <b>0</b> → <b>1</b> → <b>2</b> → <b>3</b> →.....→ <b>9</b> → <b>A</b> → <b>b</b> → <b>c</b> → <b>d</b> → <b>E</b> → <b>F</b> repeatedly.	
	<b>3</b> Push the  button to  . Every time you push the  button, the display panel reads <b>0</b> → <b>1</b> → <b>2</b> → <b>3</b> →.....→ <b>9</b> → <b>A</b> → <b>b</b> → <b>c</b> → <b>d</b> → <b>E</b> → <b>F</b> repeatedly.	
	<b>4</b> Push the  button to  . Push the  button to set the display panel to <b>7</b> . Every time you push the  button, the display panel reads <b>0</b> → <b>1</b> → <b>2</b> → <b>3</b> →.....→ <b>9</b> → <b>A</b> → <b>b</b> → <b>c</b> → <b>d</b> → <b>E</b> → <b>F</b> repeatedly.	
	<b>5</b> Push the  button to  . Push the  button to set the display panel to <b>C</b> . Every time you push the  button, the display panel reads <b>0</b> → <b>1</b> → <b>2</b> → <b>3</b> →.....→ <b>9</b> → <b>A</b> → <b>b</b> → <b>c</b> → <b>d</b> → <b>E</b> → <b>F</b> repeatedly.	
	<b>6</b> Push the  button to set the display panel to <b>2</b> . Every time you push the  button, the display panel reads <b>0</b> → <b>1</b> → <b>2</b> → <b>3</b> →.....→ <b>9</b> → <b>A</b> → <b>b</b> → <b>c</b> → <b>d</b> → <b>E</b> → <b>F</b> repeatedly.	

	Feature	Display
	<p><b>7</b> Push the <b>Mode</b> button to  . Push the <b>Fan</b> button to set the display panel to <b>6</b>. Every time you push the <b>Fan</b> button, the display panel reads <b>0</b> → <b>1</b> → <b>2</b> → <b>3</b> → ..... → <b>9</b> → <b>A</b> → <b>b</b> → <b>c</b> → <b>d</b> → <b>E</b> → <b>F</b> repeatedly.</p>	
	<p><b>8</b> Push the <b>Fan</b> button to set the display panel to <b>8</b>. Every time you push the <b>Fan</b> button, the display panel reads <b>0</b> → <b>1</b> → <b>2</b> → <b>3</b> → ..... → <b>9</b> → <b>A</b> → <b>b</b> → <b>c</b> → <b>d</b> → <b>E</b> → <b>F</b> repeatedly.</p>	
	<p><b>9</b> Push the <b>Mode</b> button to  . Push the <b>Fan</b> button to set the display panel to <b>8</b>. Every time you push the <b>Fan</b> button, the display panel reads <b>0</b> → <b>1</b> → <b>2</b> → <b>3</b> → ..... → <b>9</b> → <b>A</b> → <b>b</b> → <b>c</b> → <b>d</b> → <b>E</b> → <b>F</b> repeatedly.</p>	
	<p><b>10</b> Push the <b>Fan</b> button to set the display panel to <b>3</b>. Every time you push the <b>Fan</b> button, the display panel reads <b>0</b> → <b>1</b> → <b>2</b> → <b>3</b> → ..... → <b>9</b> → <b>A</b> → <b>b</b> → <b>c</b> → <b>d</b> → <b>E</b> → <b>F</b> repeatedly.</p>	
	<p><b>11</b> Push the <b>Mode</b> button to  . Push the <b>Fan</b> button to set the display panel to <b>1</b>. Every time you push the <b>Fan</b> button, the display panel reads <b>0</b> → <b>1</b> → <b>2</b> → <b>3</b> → ..... → <b>9</b> → <b>A</b> → <b>b</b> → <b>c</b> → <b>d</b> → <b>E</b> → <b>F</b> repeatedly.</p>	
	<p><b>12</b> Push the <b>Mode</b> button to  .</p>	
	<p><b>13</b> Push the <b>Mode</b> button to  .</p>	
	<p><b>14</b> Push the <b>Mode</b> button to  .</p>	

**Step 3** Upon completion of the selection, check you made right selections.

Press the Mode  Selection key to set the display part and check the display part.  
→ The display part shows like below when each time you press Mode button.

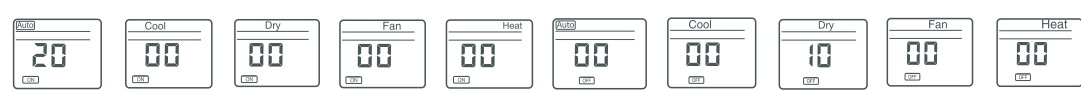

































**Step 4** Pressing the ON/OFF button .

When pressing the operation ON/OFF key with the direction of remote control for the sound "Ding" or "Diriring" is heard and the OPERATION ICON (≡) lamp of the display is flickering at the same time, then the input of option is completed.  
(If the deriving sound isn't heard, try again pressing the ON/OFF button.)

## Step 5

Enter the Options Setup mode and select your options according to the following procedure.

	Feature	Display
	<p>1 Step 1 (Enter the Option Setup mode) is executed. (Seg25 ~ 48 for setting remote control Setup)</p>	
	<p>2 Push the  Mode button to set the display panel to 2. Every time you push the  button, the display panel reads 0-1-2 → 3-... 9-A-b-c-d-E-F repeatedly.</p>	
	<p>3 Push the  button to </p>	
	<p>4 Push the  button to </p>	
	<p>5 Push the  button to </p>	
	<p>6 Push the  button to </p>	
	<p>7 Push the  button to </p>	
	<p>8 Push the  button to </p>	
	<p>9 Push the  button to </p>	
	<p>10 Push the  Mode button to set the display panel to 1. Every time you push the  button, the display panel reads 0-1-2 → 3-... 9-A-b-c-d-E-F repeatedly.</p>	
	<p>11 Push the  button to </p>	
	<p>12 Push the  button to </p>	



**Step 6** Upon completion of the selection, check you made right selections.

Press the Mode  Selection key to set the display part and check the display part.  
 → The display part shows like below when each time you press Mode button.

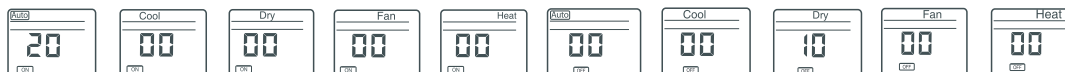

**Step 7** Pressing the ON/OFF button ().

When pressing the operation ON/OFF key with the direction of remote control for unit, the sound "Ding" or "Dirring" is heard and the OPERATION ICON(  ) lamp of the display is flickering at the same time, then the input of option is completed.  
 (If the deriving sound isn't heard, try again pressing the ON/OFF button.)

**Step 8** Unit operation test-run.

- First** : Remove the battery from the remote control.
- Second** : Re-insert the battery into the remote control.
- Third** : Press ON/OFF key with the direction of remote control for set.

■ Error mode

1. If all lamps of indoor unit are flickering, Plug out, plug in power plug again and press ON/OFF key to retry.
2. If the unit is not working properly or all lamps are continuously flickering after setting the option code, see if the correct option code is set up for its model.

□ Option Items



Model	SEG 1~24	SEG 25~48	SEG 49~72
AR09NXPDPWKNEE	011045-196A66-271920-37133F	020000-100000-200001-300000	03433A-111E29-200000-300001
AR12NXPDPWKNEE	011045-176A88-272328-37153F	020000-100000-200001-300000	035042-102F35-200000-300001

---





## 4. Disassembly and Reassembly

---





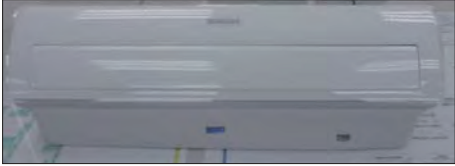



### ■ Necessary Tools

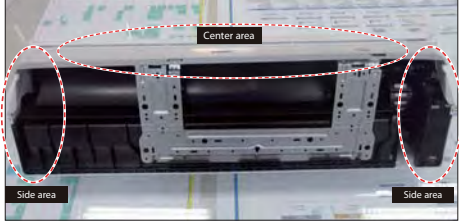

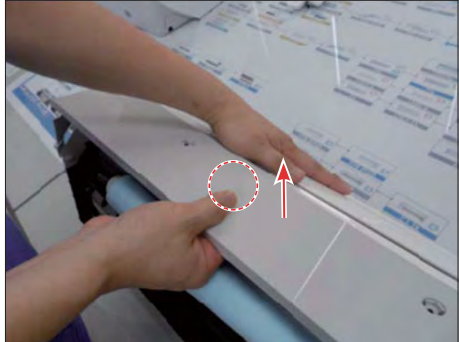
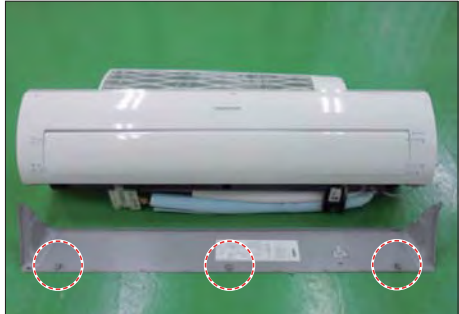

Item	Remark
SCREW DRIVER	
MONKEY SPANNER	

## 4-1 Indoor Unit

No	Parts	Procedure	Remark
1	PANEL-FRONT	<p>1) Stop the driving of air conditioner and shut of main power supply</p> <p>2) Detach FILTER PRE from the PANEL FRONT.</p> <p>3) Cover Panel is assembled on bottom of indoor unit as shown in the figure. Remove the Cap Screw as shown on the right side and then remove the screw and separate the Cover Panel.</p>	   

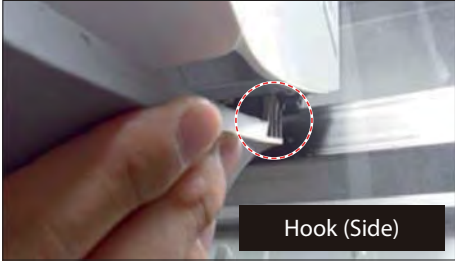

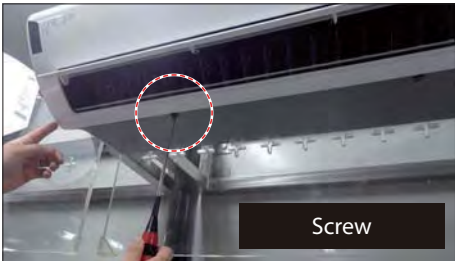
No	Parts	Procedure	Remark						
		<p>4) Cover Panel is fixed to body by Hook in center area and side area.</p> <p>5) Separate the hook after pushing both end of Cover Panel as shown in the figure. (Watch out for the damage of the hook)</p> <p>6) Raise front part upward obliquely as shown in the figure and then remove the hooks.</p>	 <table border="1" data-bbox="938 577 1398 734"> <thead> <tr> <th colspan="2">HOOK</th> </tr> </thead> <tbody> <tr> <td>9/12K</td> <td></td> </tr> <tr> <td>18/24/30K</td> <td></td> </tr> </tbody> </table>   	HOOK		9/12K		18/24/30K	
HOOK									
9/12K									
18/24/30K									

No	Parts	Procedure	Remark
		<p><b>⚠ Caution:</b>            Assembly of Cover Panel after service end.</p> <ul style="list-style-type: none"> <li>- Reassembly is in the reverse order of the removal.</li> <li>- Piping and drain hose must be careful not to damage and Progress must be done with both hands.</li> </ul>	    



No	Parts	Procedure	Remark
		<p>7) To detach the PANEL-FRONT from the main frame, unfasten 2 screws at the bottom. (use + Screw Driver)</p> <p>8) To detach the COVER-PANEL from the main frame, loosen 4 HOOK Structures. When separate the hook: Use the (-) screw Driver. (-)Screw Driver Insert the hook and then pull the hook as shown on the right side. (Watch out for the damage of the hook)</p>	   

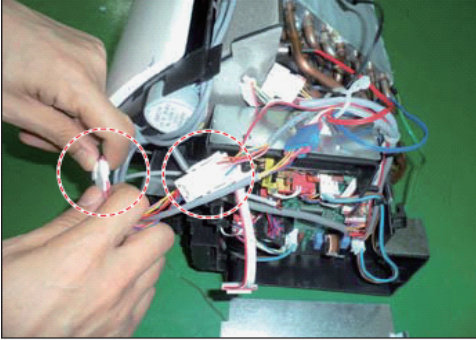
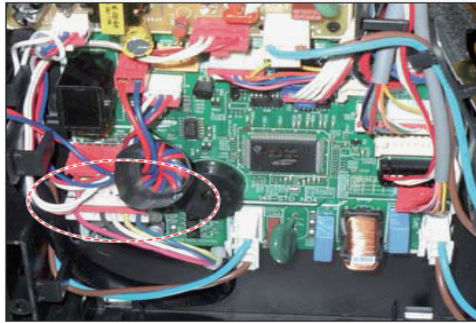
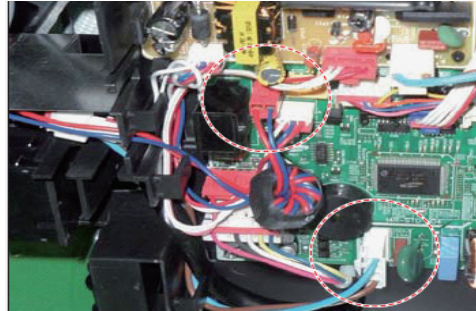
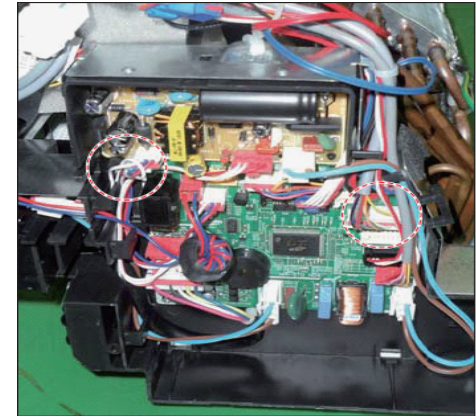

No	Parts	Procedure	Remark
		<p>9) Remove the Panel Frame from the Main Frame as shown on the right side.</p>	
		<p>10) Remove the WIFI KIT connector. WIFI KIT connector is located of Panel Front. (For model with WIFI KIT)</p>	

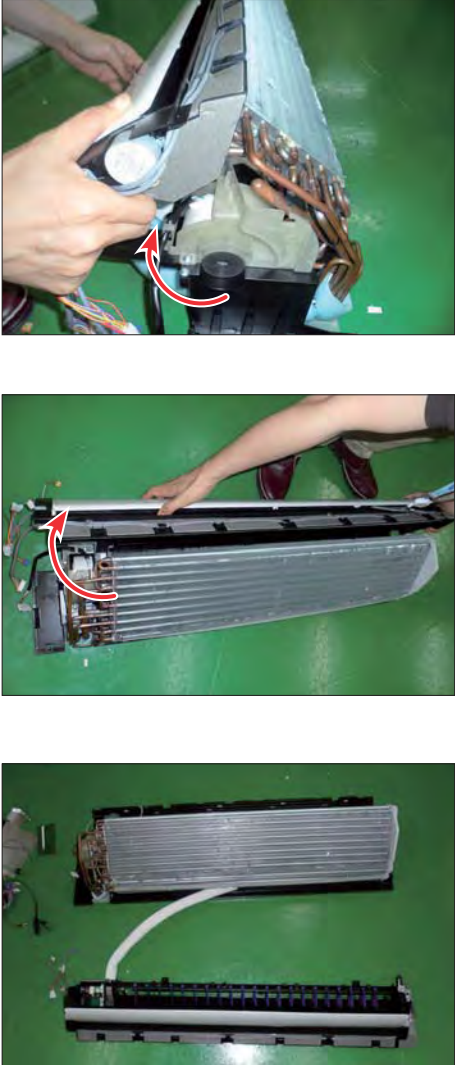
No	Parts	Procedure	Remark
7	CONTROL IN	<p>5) Cut off CABLE TIE, take off SENSOR WIRE and Screw</p> <p>6) Loosen MOTOR Wire</p> <p><b>⚠ Caution :</b> When you separate the connector, pull pressing the locking button.</p> <p>7) Loosen the terminal block wires.</p> <p><b>⚠ Caution :</b> When you separate the connector, pull pressing the locking button.</p> <p>8) Loosen the Thermistor wire connector, Display wire connector.</p> <p><b>⚠ Caution :</b> When you separate the connector, pull pressing the locking button.</p>	   



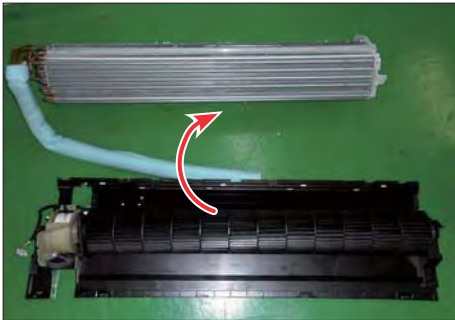

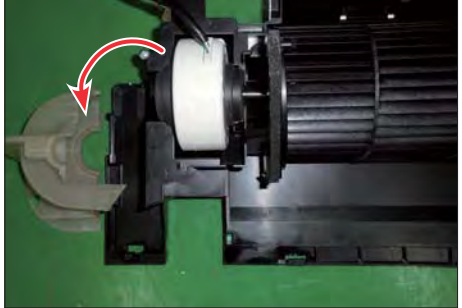

No	Parts	Procedure	Remark
5	EVAPORATOR	<p>9) Take off the CASE-CONTROL from the main frame after loosen the remaining connector.</p> <p><b>⚠ Caution:</b> When you separate the connector, pull pressing the locking button.</p>	
3	TRAY DRAIN	<p>1) To detach TRAY-DRAIN from the main frame, pull the bottom of the TRAY-DRAIN towards you.</p>	



No	Parts	Procedure	Remark
4	Evaporator	<p>1) Detach the HOLDER PIPE.</p> <p>2) Unfasten the screw at the left side. (use + Screw Driver)</p> <p>3) Unfasten the screw at the right side. (use + Screw Driver)</p> <p>4) To detach Evaporator from the main frame, pull the bottom of the Evaporator towards you.</p>	   

No	Parts	Procedure	Remark
5	FAN MOTOR & CROSS FAN	<p>1) Unfasten the screw. (use + Screw Driver)</p> <p>2) Detach the FAN Motor case.</p> <p>3) Unfasten the screw a little. (use + Screw Driver)</p> <p>4) Pull the CROSS-FAN to the left side.</p>	   







## 4-2 Outdoor Unit

No	Parts	Procedure	Remark
1	Common Work	<p>1) Loosen 1 fixing screw(CCW) of the Cover-Side. (Use +Screw Driver.)</p> <p>2) Loosen each 5 screws(CCW) on both right and left Cabinet Side edges and a fixing screw on the Cabinet Front lower to detach the Cabinet Front. (Use +Screw Driver.)</p> <p>3) Detach the Cabinet Upper like the picture.</p> <p>4) Loosen 2 screw(CCW) fixed to assemble Plate Control Out with Cabinet-Side RH. (Use +Screw Driver.)</p>	   

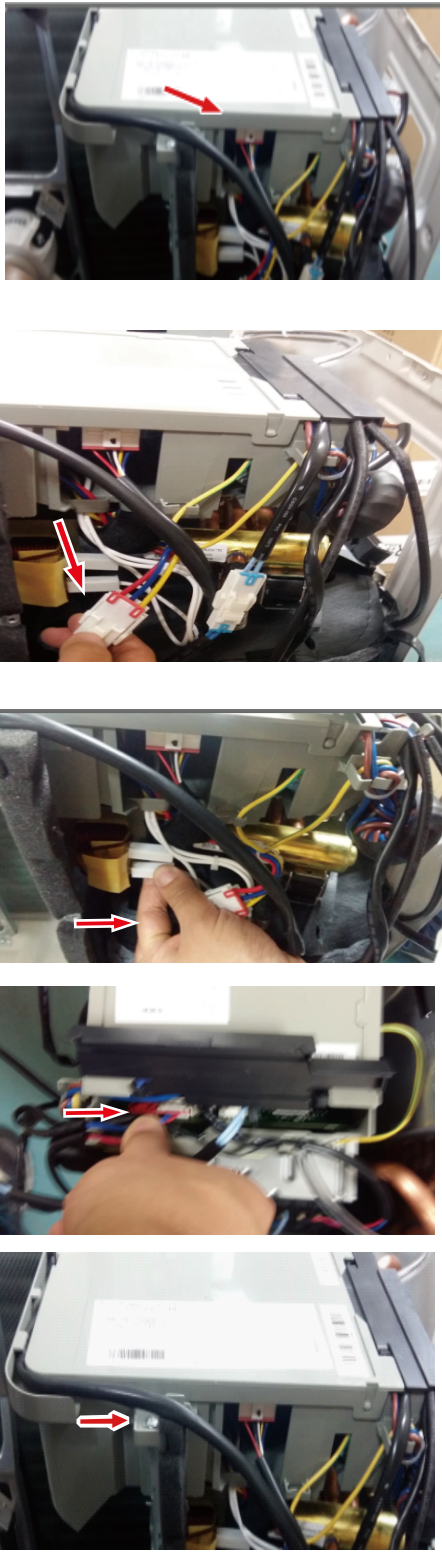

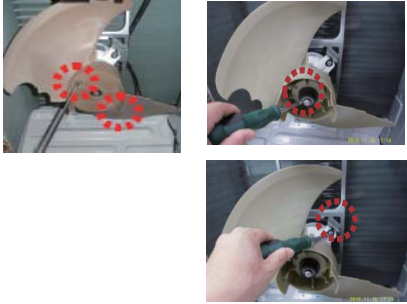
No	Parts	Procedure	Remark
1	Common Work	<p>5) Loosen 2 screw(CCW) on the right side of Cabinet Front. (Use □Screw Driver)</p> <p>6) Loosen 2 screw(CCW) on the left side of Cabinet Front. (Use □Screw Driver)</p> <p>7) Loosen 3 screw(CCW) on the front side of Cabinet Front. (Use □Screw Driver)</p>	  

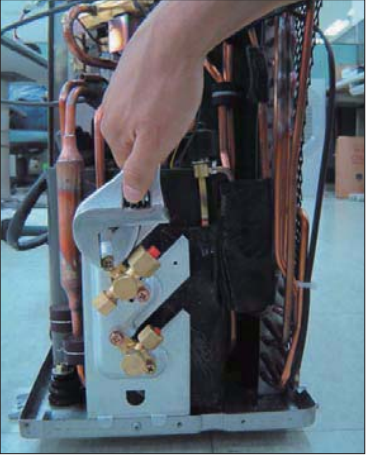
No	Parts	Procedure	Remark
		<p>8) Loosen 4 fixing screws(CCW) on the rear side of Cabinet-Side RH. (Use +Screw Driver.)</p> <p>9) Loosen 3 screws(CCW) fixed to assemble Bracket Valve with Cabinet-Side RH. (Use +Screw Driver.)</p>	 



No	Parts	Procedure	Remark
2	Ass'y Control Out	<p>1) Detach the Motor Wire from the PCB of Ass'y Control Out.</p> <p>2) Detach several connectors from the PCB of Ass'y Control Out.</p> <p>3) Detach 2 Connect Wires from Reactor.</p> <p>4) Loosen 1 screw(CCW) fixed to assemble Ass'y Control Out with Partition. (Use +Screw Driver.)</p>	

No	Parts	Procedure	Remark
3	Fan & Motor	<ol style="list-style-type: none"> <li>1) Release 2 screw at CAP FAN</li> <li>2) Release Nut at Fan Boss</li> <li>3) Release 3 screws st Motor Bracket.</li> <li>4) Detach Motor Wire from the Assy Control Out.</li> </ol>	
4	Heat Exchanger	<ol style="list-style-type: none"> <li>1) Loosen 1 fixing screws(CCW) on both sides. (Use +Screw Driver.)</li> <li>2) Disassemble the pipes in both inlet and outlet with welding torch.</li> <li>3) Detach the Heat Exchanger.</li> </ol> <p><b>⚠ Before you disassemble the pipes and Condenser, be sure that there should be no refrigerant remained in the unit.</b></p>	
5	Ass'y Valve 4-Way & Ass'y Valve EEV	<ol style="list-style-type: none"> <li>1) Loosen 4 bolts(CCW) fixed to assemble Valve Service with Bracket Valve like the picture on the right side. (Use Monkey Spanner.)</li> <li>2) Disassemble the pipes assembled the suction and discharge sides of the Compressor with welding torch.</li> </ol>	
6	Compressor	<ol style="list-style-type: none"> <li>1) Loosen the Nut(CCW) of Terminal Cover. (Use Monkey Spanner.)</li> <li>2) Detach the Terminal Cover and detach the Connect Comp Wire from Compressor.</li> <li>3) Disassemble the Felt Comp Sound.</li> <li>4) Loosen the 3 bolts(CCW) at the bottom of Compressor like the picture on the right side. (Use Monkey Spanner.)</li> </ol>	

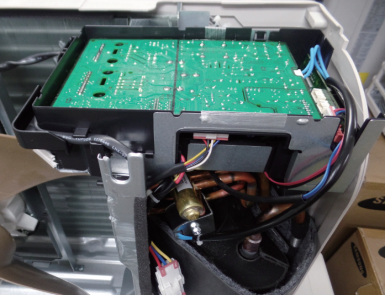
### 4-3. EEPROM DOWNLOAD

No	Parts	Procedure	Remark
1	Normal	<p>1) Power off</p> <p>2) Take off the Cabinet : Check the LED off</p> <p>3) Connect PC-Download Jig-PBA</p>	   <div data-bbox="997 1153 1374 1205" style="border: 1px solid red; padding: 2px; text-align: center;">Download Connector (10pin)</div> 

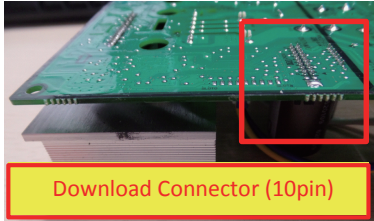
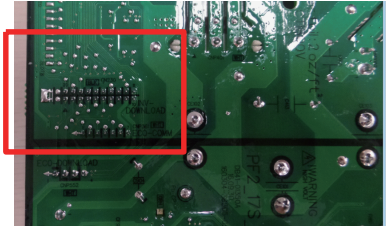
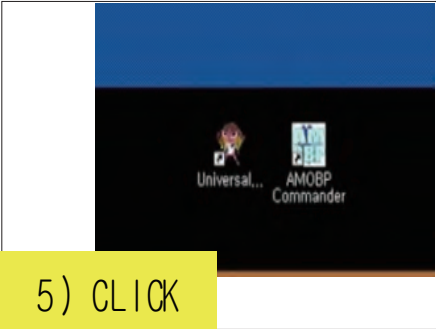
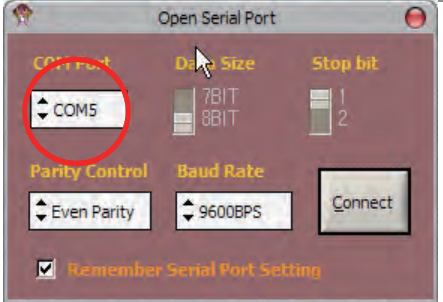

No	Parts	Procedure	Remark
		<p>3) Connect PC-Download Jig-PBA</p> <p>5) Execute the Universal EEPwriter program</p> <p>6) Select COM Port and connect</p> <p>7) Open the file 8) Start Download</p>	 <p>Download Connector (10pin)</p>   <p>5) CLICK</p>  <p>6) Select COM Port and connect</p>  <p>7) CLICK</p> <p>8) CLICK</p>

## 5. Disassembly WIFI(Only apply for WIFI model)

### 5-1 WIFI Case

No	Parts	Procedure	Remark
1	CASE	Separate Case-WIFI Top from Case-WIFI Button	
2	BUTTON	Separate Case-WIFI Top from Case-WIFI Button	
3	SCREW	Detach SCREW from Case-WIFI Button	
4	WIRE	Detach Assy Connector Wire from Case-WIFI Button  *Caution When you separate the connector, pull pressing the locking button	
5	PBA	Separate PBA WIFI from Case-WIFI Button	



## 5-2 ASSY KIT -DB92-04419B

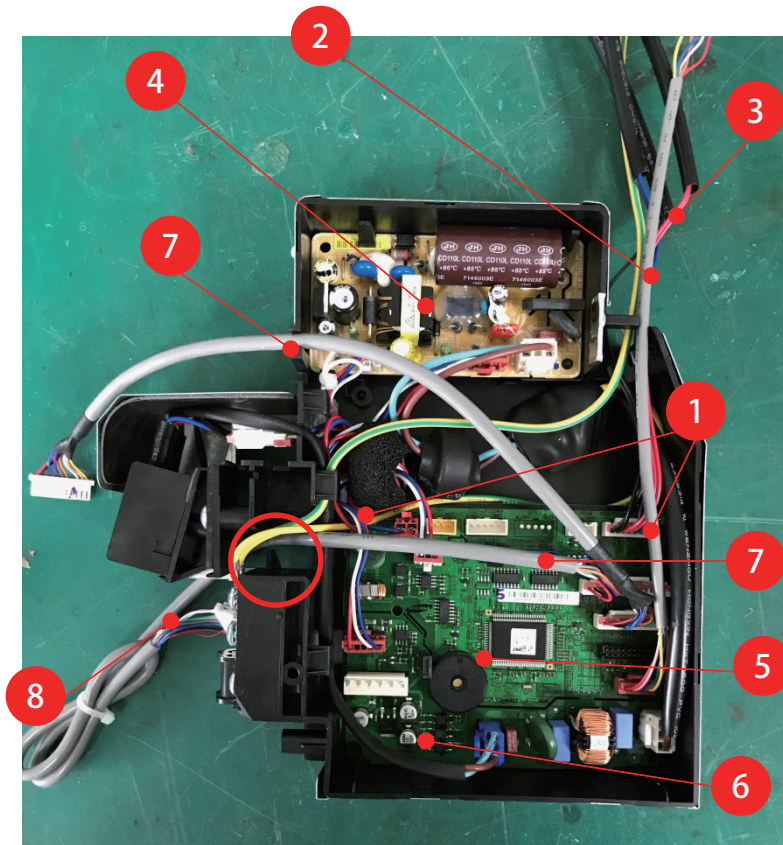

Div.	Part Name	Part No	Qty
1	SCREW-TAPPING	6002-000630	2
2	ASSY CONNECTOR WIRE-DC SIGNAL	DB93-15445A	1
3	ASSY THERMISTOR IN	DB95-05163A	1
4	ASSY MODULE	DB92-02861B	1
5	ASSY PCB MAIN	DB92-04101B	1
6	ASSY CONNECTOR WIRE-DC SIGNAL	DB93-14208A	1
7	ASSY CONNECTOR WIRE-DISPLAY	DB93-14209A	1
8	ASSY CONNECTOR WIRE-DC SIGNAL	DB93-14221A	1
9	ASSY CONNECTOR WIRE-DC SIGNAL	DB93-15445A	1
10	ASSY THERMISTOR IN	DB95-05163A	1

## 5-2 ASSY CONTROL OUT(DB93-16804C)

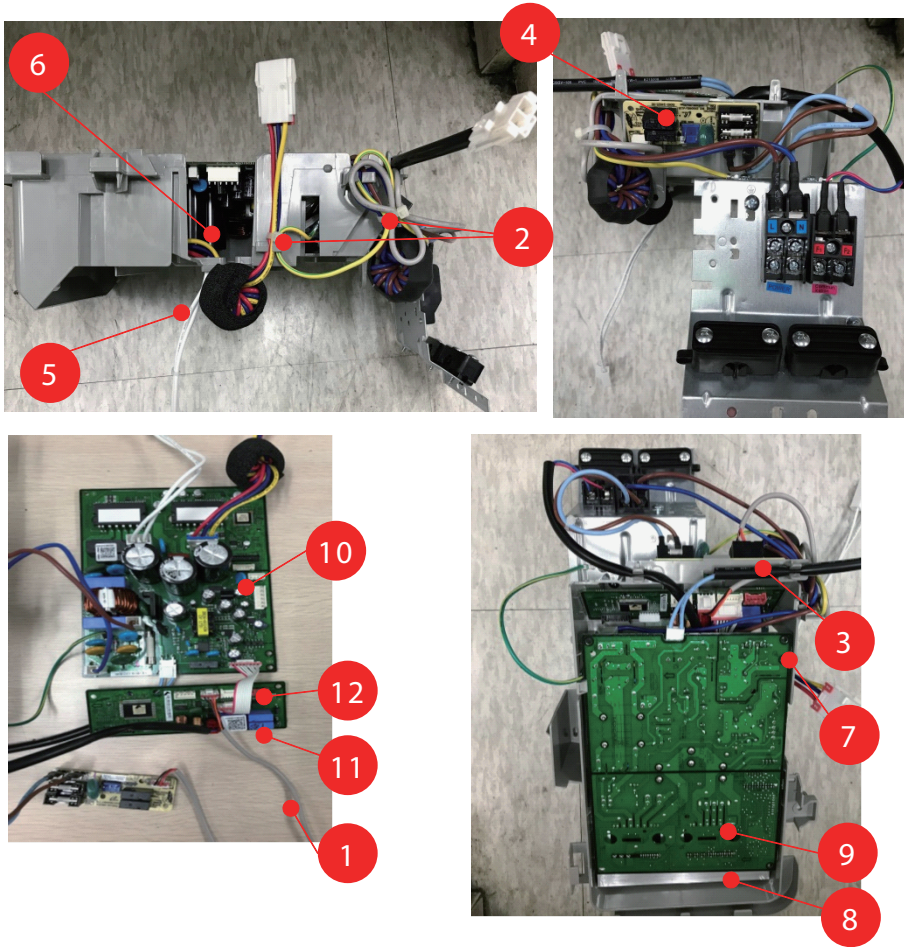

Div.	Part Name	Part No	Qty
1	ASSY CONNECTOR WIRE-DC SIGNAL	DB93-16704A	1
2	CABLE TIE	DB65-10088B	2
3	ASSY CONNECTOR WIRE-AC SIGNAL	DB93-16403A	1
4	ASSY PCB SUB-HEATER	DB93-13220A	1
5	ASSY CONNECTOR WIRE-REACTOR	DB93-15320A	1
6	ASSY CONNECTOR WIRE	DB93-09497E	1
7	SCREW-TAPPING	6002-000630	1
8	HEAT SINK	DB62-12196B	1
9	ASSY-SCREW MACHINE	DB91-00933A	4
10	ASSY PCB INVERTER	DB92-04025D	1
11	ASSY PCB MAIN	DB92-04029E	1
12	ASSY CONNECTOR WIRE-DC SIGNAL	DB93-07452B	1

## 6. Electrical Parts List

### 6-1 INDOOR MAIN PCB ( DB92-04101B)

Level	Parts Code	Design Loc	Parts Description	Spec.	Quantity	Unit
..1	0201-001528	COATING	ADHESIVE-SIL	LDC2577D,Y/GRN,175CPS	2.0	G
..1	0201-001982	ADHESIVE-SIL	ADHESIVE-SIL	TSE3854DS-W,White,2.2,MIL-A-46146B,UL94V-0	0.0037	KG
..1	0202-001338	SOLDER-BAR	SOLDER-BAR	Lead-free Solder BAR,W20L350H8,99.3Sn/0.7Cu/0.01P	0.17	G
..1	0202-001463	SOLDER-WIRE	SOLDER-WIRE	LFC2-W3.0,D3,99.79Sn/0.2Cu/0.01P,No Flux	1.51	G
..1	0204-004665	FLUX	FLUX	KSP-70M-S,MIXTURE,NO,FLUX,13%	0.14	G
..1	0204-005794	SOLVENT	SOLVENT	S-1000,(CH3)2CHOH,100%,0.79	1.0	G
..1	0502-000245	Q701	TR-POWER	KSB1151-Y,PNP,1300mW,TO-126,160-320	1.0	PC
..1	1405-001239	VA71	VARISTOR	680V,560VDC,6000A,17x10mm,TP,1120V,350pF,D14	1.0	PC
..1	2301-002032	XC71	C-FILM,LEAD-PPF	100nF,10%,275V,TP,12.5x6x12mm	1.0	PC
..1	2301-002032	XC72	C-FILM,LEAD-PPF	100nF,10%,275V,TP,12.5x6x12mm	1.0	PC
..1	3002-001139	BZ61	BUZZER-PIEZO	80dB,9V,2KHz,BK	1.0	PC
..1	3711-000024	CN76	HEADER-BOARD TO CABLE	BOX,3P,1R,2.5MM,STRAIGHT,SN,WHT	1.0	PC
..1	3711-000177	CN21	HEADER-BOARD TO CABLE	1WALL,2P,1R,3.96MM,STRAIGHT,SN,RED	1.0	PC
..1	3711-000203	CN75	HEADER-BOARD TO CABLE	1WALL,2P,1R,7.92mm,STRAIGHT,SN,WHT,11.82x8.6x9.4mm	1.0	PC
..1	3711-000296	CN72	HEADER-BOARD TO CABLE	1WALL,6P,1R,3.96MM,STRAIGHT,SN,WHT	1.0	PC
..1	3711-000941	CN81	HEADER-BOARD TO CABLE	BOX,4P,1R,2.5mm,STRAIGHT,SN,YEL	1.0	PC
..1	3711-000998	CN77	CONNECTOR-HEADER	BOX,5P,1R,2.5MM,STRAIGHT,SN,RED	1.0	PC
..1	3711-000999	CN61	HEADER-BOARD TO CABLE	BOX,5P,1R,2.5mm,STRAIGHT,SN,WHT,5.8x14.9x7.0mm	1.0	PC
..1	3711-002001	CN31	HEADER-BOARD TO CABLE	BOX,20P,2R,2.0mm,STRAIGHT,SN,BLK,5.0x22.0x6.6mm	1.0	PC
..1	3711-003404	CN71	HEADER-BOARD TO CABLE	1WALL,2P,1R,7.92mm,STRAIGHT,SN,BLU	1.0	PC
..1	3711-003845	CN91	HEADER-BOARD TO CABLE	BOX,11P,1R,2mm,STRAIGHT,SN,WHT	1.0	PC
..1	3711-004122	CN32	HEADER-BOARD TO CABLE	BOX,14P,1R,2mm,STRAIGHT,SN,WHT	1.0	PC
..1	3711-004236	CN43	HEADER-BOARD TO CABLE	BOX,6P,1R,2mm,STRAIGHT,SN,WHT	1.0	PC
..1	3711-004379	CN42	HEADER-BOARD TO CABLE	BOX,4P,1R,2mm,STRAIGHT,SN,WHT	1.0	PC
..1	3711-005096	CN63	HEADER-BOARD TO CABLE	BOX,5P,1R,2MM,STRAIGHT,SN,BLK	1.0	PC
..1	3711-005097	CN62	HEADER-BOARD TO CABLE	BOX,5P,1R,2MM,STRAIGHT,SN,BLU	1.0	PC
..1	DB27-00096A	FT71	COIL CHOKE	CV1615280,COIL CHOKE,28.0mH,+50~-30%,268.0m ohm	1.0	PC
..1	DB27-00102A	FT81	COIL CHOKE	1.0mH,2.5A,8.4x3.4,Mn-Zn,4,DIP	1.0	PC
..1	DB68-05458A	LABEL BAR CODE	LABEL BAR CODE	AM9000H,ART,W17.5,L18	1.0	PC
..1	DB94-07156A	-	ASSY PCB AUTO	MAIN,AR9500M,120X98mm,N,220V-240V,19V,12V,5V	1.0	PC
....2	0501-000362	Q801	TR-SMALL SIGNAL	KSC2328A-Y,NPN,1000mW,TO-92L,TP,160~320	1.0	PC
....2	1404-001194	PTC2	THERMISTOR-PTC	39ohm,20%,220/240V,270Vac,1.2A,TP	1.0	PC
....2	3601-001765	F701	FUSE-RADIAL LEAD	250V,3.15A,TIME-LAG,Thermoplastic,8.5x8mm	1.0	PC
....2	3711-005098	CN51	HEADER-BOARD TO CABLE	BOX,5P,1R,2MM,STRAIGHT,SN,RED	1.0	PC
....2	DB94-07157A	-	ASSY PCB SMD	MAIN,AR9500M,120X98mm,N,220V-240V,19V,12V,5V	1.0	PC
.....3	0202-001933	SOLDER-CREAM	SOLDER-CREAM	LFM-48W TM-HP,D20~38um,96.5Sn/3Ag/0.5Cu,Flux 12%	0.32	G
.....3	0402-001741	D701	DIODE-RECTIFIER	S1M,1000V,1A,SMA,TP	1.0	PC
.....3	0406-001005	TD420	DIODE-TVS	SM05,6V,20MAV,TP	1.0	PC
.....3	0406-001005	TD501	DIODE-TVS	SM05,6V,20MAV,TP	1.0	PC
.....3	0406-001204	CD81	DIODE-TVS	SMBJ5.0CA,6.4/-7.25V,600W,SMB	1.0	PC
.....3	0406-001204	CD82	DIODE-TVS	SMBJ5.0CA,6.4/-7.25V,600W,SMB	1.0	PC
.....3	0406-001204	CD83	DIODE-TVS	SMBJ5.0CA,6.4/-7.25V,600W,SMB	1.0	PC
.....3	0501-000465	Q501	TR-SMALL SIGNAL	MMBT3904,NPN,350mW,SOT-23,TP,30~300	1.0	PC
.....3	0501-000465	Q702	TR-SMALL SIGNAL	MMBT3904,NPN,350mW,SOT-23,TP,30~300	1.0	PC
.....3	0504-001080	Q601	TR-DIGITAL	KRC246S,NPN,200mW,2.2K/10Kohm,SOT-23,TP	1.0	PC
.....3	0504-001080	Q802	TR-DIGITAL	KRC246S,NPN,200mW,2.2K/10Kohm,SOT-23,TP	1.0	PC
.....3	0506-000175	IC05	TR-ARRAY	2003,NPN,7,1000mW,SOP-16,TP,1000	1.0	PC
.....3	0506-000175	IC06	TR-ARRAY	2003,NPN,7,1000mW,SOP-16,TP,1000	1.0	PC
.....3	0604-001002	PC03	PHOTO-COUPLER	TR,100-600%,170mW,SOP-4,TP	1.0	PC
.....3	0604-001002	PC04	PHOTO-COUPLER	TR,100-600%,170mW,SOP-4,TP	1.0	PC
.....3	0604-001002	PC05	PHOTO-COUPLER	TR,100-600%,170mW,SOP-4,TP	1.0	PC
.....3	0801-000393	IC08	IC-CMOS LOGIC	74HC86,OR GATE,SOP,14P,150MIL,QUAD,TP,2.0/6.0V	1.0	PC
.....3	1006-001325	IC07	IC-BUS TRANSCEIVER	SO,8P,4.9x3.8 mm,SINGLE,ST,PLASTIC,5V,-40to+85C	1.0	PC
.....3	1202-000104	IC11	IC-VOLTAGE COMP.	393,SOP,8P,150MIL,DUAL,36V,CMOS,PLASTIC,18V,780mW	1.0	PC
.....3	1203-006245	IC03	IC-VOL. DETECTOR	KIA7033AT,TSM,3P,2.9x1.6x0.7mm,PLASTIC,3.3V,350mW	1.0	PC
.....3	1203-007526	IC02	IC-POSIFIXED REG.	7815,TO-252,3P,6.6*6.1mm,14.4/15.6V,1.3W,-40to+125C,TP	1.0	PC
.....3	2007-000039	R717	R-CHIP	0ohm,1%,1/10W,TP,1608	1.0	PC
.....3	2007-000043	R703	R-CHIP	1Kohm,1%,1/10W,TP,1608	1.0	PC
.....3	2007-000043	R706	R-CHIP	1Kohm,1%,1/10W,TP,1608	1.0	PC
.....3	2007-000043	R805	R-CHIP	1Kohm,1%,1/10W,TP,1608	1.0	PC
.....3	2007-000043	R815	R-CHIP	1Kohm,1%,1/10W,TP,1608	1.0	PC
.....3	2007-000052	R701	R-CHIP	10Kohm,1%,1/10W,TP,1608	1.0	PC
.....3	2007-000052	R704	R-CHIP	10Kohm,1%,1/10W,TP,1608	1.0	PC
.....3	2007-000052	R705	R-CHIP	10Kohm,1%,1/10W,TP,1608	1.0	PC
.....3	2007-000052	R723	R-CHIP	10Kohm,1%,1/10W,TP,1608	1.0	PC
.....3	2007-000052	R801	R-CHIP	10Kohm,1%,1/10W,TP,1608	1.0	PC
.....3	2007-000052	R802	R-CHIP	10Kohm,1%,1/10W,TP,1608	1.0	PC
.....3	2007-000052	R803	R-CHIP	10Kohm,1%,1/10W,TP,1608	1.0	PC
.....3	2007-000052	R804	R-CHIP	10Kohm,1%,1/10W,TP,1608	1.0	PC
.....3	2007-000052	R816	R-CHIP	10Kohm,1%,1/10W,TP,1608	1.0	PC
.....3	2007-000116	R825	R-CHIP	120ohm,5%,1/10W,TP,1608	1.0	PC
.....3	2007-000143	R511	R-CHIP	4.7Kohm,5%,1/16W,TP,1005	1.0	PC
.....3	2007-000143	R512	R-CHIP	4.7Kohm,5%,1/16W,TP,1005	1.0	PC
.....3	2007-000143	R513	R-CHIP	4.7Kohm,5%,1/16W,TP,1005	1.0	PC
.....3	2007-000143	R552	R-CHIP	4.7Kohm,5%,1/16W,TP,1005	1.0	PC

## 6. Electrical Parts List

### 6-1 INDOOR MAIN PCB

Level	Parts Code	Design Loc	Parts Description	Spec.	Quantity	Unit
.....3	2007-000148	R412	R-CHIP	10Kohm,5%,1/16W,TP,1005	1.0	PC
.....3	2007-000148	R413	R-CHIP	10Kohm,5%,1/16W,TP,1005	1.0	PC
.....3	2007-000148	R502	R-CHIP	10Kohm,5%,1/16W,TP,1005	1.0	PC
.....3	2007-000148	R503	R-CHIP	10Kohm,5%,1/16W,TP,1005	1.0	PC
.....3	2007-000148	R504	R-CHIP	10Kohm,5%,1/16W,TP,1005	1.0	PC
.....3	2007-000148	R505	R-CHIP	10Kohm,5%,1/16W,TP,1005	1.0	PC
.....3	2007-000148	R506	R-CHIP	10Kohm,5%,1/16W,TP,1005	1.0	PC
.....3	2007-000148	R521	R-CHIP	10Kohm,5%,1/16W,TP,1005	1.0	PC
.....3	2007-000148	R522	R-CHIP	10Kohm,5%,1/16W,TP,1005	1.0	PC
.....3	2007-000148	R523	R-CHIP	10Kohm,5%,1/16W,TP,1005	1.0	PC
.....3	2007-000148	R524	R-CHIP	10Kohm,5%,1/16W,TP,1005	1.0	PC
.....3	2007-000148	R525	R-CHIP	10Kohm,5%,1/16W,TP,1005	1.0	PC
.....3	2007-000148	R526	R-CHIP	10Kohm,5%,1/16W,TP,1005	1.0	PC
.....3	2007-000148	R527	R-CHIP	10Kohm,5%,1/16W,TP,1005	1.0	PC
.....3	2007-000148	R528	R-CHIP	10Kohm,5%,1/16W,TP,1005	1.0	PC
.....3	2007-000148	R529	R-CHIP	10Kohm,5%,1/16W,TP,1005	1.0	PC
.....3	2007-000148	R530	R-CHIP	10Kohm,5%,1/16W,TP,1005	1.0	PC
.....3	2007-000148	R531	R-CHIP	10Kohm,5%,1/16W,TP,1005	1.0	PC
.....3	2007-000148	R532	R-CHIP	10Kohm,5%,1/16W,TP,1005	1.0	PC
.....3	2007-000148	R533	R-CHIP	10Kohm,5%,1/16W,TP,1005	1.0	PC
.....3	2007-000148	R534	R-CHIP	10Kohm,5%,1/16W,TP,1005	1.0	PC
.....3	2007-000148	R543	R-CHIP	10Kohm,5%,1/16W,TP,1005	1.0	PC
.....3	2007-000148	R544	R-CHIP	10Kohm,5%,1/16W,TP,1005	1.0	PC
.....3	2007-000148	R551	R-CHIP	10Kohm,5%,1/16W,TP,1005	1.0	PC
.....3	2007-000148	R555	R-CHIP	10Kohm,5%,1/16W,TP,1005	1.0	PC
.....3	2007-000148	R556	R-CHIP	10Kohm,5%,1/16W,TP,1005	1.0	PC
.....3	2007-000148	R557	R-CHIP	10Kohm,5%,1/16W,TP,1005	1.0	PC
.....3	2007-000148	R807	R-CHIP	10Kohm,5%,1/16W,TP,1005	1.0	PC
.....3	2007-000148	R808	R-CHIP	10Kohm,5%,1/16W,TP,1005	1.0	PC
.....3	2007-000148	R810	R-CHIP	10Kohm,5%,1/16W,TP,1005	1.0	PC
.....3	2007-000148	R824	R-CHIP	10Kohm,5%,1/16W,TP,1005	1.0	PC
.....3	2007-000148	R826	R-CHIP	10Kohm,5%,1/16W,TP,1005	1.0	PC
.....3	2007-000148	R903	R-CHIP	10Kohm,5%,1/16W,TP,1005	1.0	PC
.....3	2007-000148	R904	R-CHIP	10Kohm,5%,1/16W,TP,1005	1.0	PC
.....3	2007-000157	R902	R-CHIP	47Kohm,5%,1/16W,TP,1005	1.0	PC
.....3	2007-000162	R820	R-CHIP	100Kohm,5%,1/16W,TP,1005	1.0	PC
.....3	2007-000162	R821	R-CHIP	100Kohm,5%,1/16W,TP,1005	1.0	PC
.....3	2007-000171	R831	R-CHIP	0ohm,5%,1/16W,TP,1005	1.0	PC
.....3	2007-000171	R833	R-CHIP	0ohm,5%,1/16W,TP,1005	1.0	PC
.....3	2007-000171	R835	R-CHIP	0ohm,5%,1/16W,TP,1005	1.0	PC
.....3	2007-000171	R837	R-CHIP	0ohm,5%,1/16W,TP,1005	1.0	PC
.....3	2007-000171	R839	R-CHIP	0ohm,5%,1/16W,TP,1005	1.0	PC
.....3	2007-000171	R843	R-CHIP	0ohm,5%,1/16W,TP,1005	1.0	PC
.....3	2007-000299	R702	R-CHIP	10Kohm,1%,1/4W,TP,3216	1.0	PC
.....3	2007-000385	R115	R-CHIP	14.3Kohm,1%,1/4W,TP,3216	1.0	PC
.....3	2007-000455	R712	R-CHIP	18Kohm,1%,1/10W,TP,1608	1.0	PC
.....3	2007-000475	R709	R-CHIP	1Mohm,1%,1/10W,TP,1608	1.0	PC
.....3	2007-000583	R714	R-CHIP	22Kohm,1%,1/10W,TP,1608	1.0	PC
.....3	2007-000763	R601	R-CHIP	330ohm,1%,1/10W,TP,1608	1.0	PC
.....3	2007-000763	R602	R-CHIP	330ohm,1%,1/10W,TP,1608	1.0	PC
.....3	2007-000763	R716	R-CHIP	330ohm,1%,1/10W,TP,1608	1.0	PC
.....3	2007-000828	R715	R-CHIP	39Kohm,1%,1/10W,TP,1608	1.0	PC
.....3	2007-000869	R707	R-CHIP	4.7Kohm,1%,1/10W,TP,1608	1.0	PC
.....3	2007-000924	R112	R-CHIP	470Kohm,1%,1/4W,TP,3216	1.0	PC
.....3	2007-000924	R113	R-CHIP	470Kohm,1%,1/4W,TP,3216	1.0	PC
.....3	2007-000924	R114	R-CHIP	470Kohm,1%,1/4W,TP,3216	1.0	PC
.....3	2007-000939	R711	R-CHIP	47Kohm,1%,1/10W,TP,1608	1.0	PC
.....3	2007-000979	R713	R-CHIP	5.6Kohm,1%,1/10W,TP,1608	1.0	PC
.....3	2007-001068	R708	R-CHIP	6.8Kohm,1%,1/10W,TP,1608	1.0	PC
.....3	2007-001313	R404	R-CHIP	330ohm,5%,1/16W,TP,1005	1.0	PC
.....3	2007-001313	R405	R-CHIP	330ohm,5%,1/16W,TP,1005	1.0	PC
.....3	2007-001313	R406	R-CHIP	330ohm,5%,1/16W,TP,1005	1.0	PC
.....3	2007-001313	R410	R-CHIP	330ohm,5%,1/16W,TP,1005	1.0	PC
.....3	2007-001313	R411	R-CHIP	330ohm,5%,1/16W,TP,1005	1.0	PC
.....3	2007-001313	R811	R-CHIP	330ohm,5%,1/16W,TP,1005	1.0	PC
.....3	2007-001433	R618	R-CHIP	12Kohm,1%,1/10W,TP,1608	1.0	PC
.....3	2007-007306	R508	R-CHIP	100ohm,1%,1/16W,TP,1005	1.0	PC
.....3	2007-007306	R515	R-CHIP	100ohm,1%,1/16W,TP,1005	1.0	PC
.....3	2007-007306	R516	R-CHIP	100ohm,1%,1/16W,TP,1005	1.0	PC
.....3	2007-007306	R517	R-CHIP	100ohm,1%,1/16W,TP,1005	1.0	PC
.....3	2007-007306	R518	R-CHIP	100ohm,1%,1/16W,TP,1005	1.0	PC
.....3	2007-007306	R519	R-CHIP	100ohm,1%,1/16W,TP,1005	1.0	PC
.....3	2007-007306	R520	R-CHIP	100ohm,1%,1/16W,TP,1005	1.0	PC



## 6. Electrical Parts List

### 6-1 INDOOR MAIN PCB

Level	Parts Code	Design Loc	Parts Description	Spec.	Quantity	Unit
.....3	2007-007306	R539	R-CHIP	100ohm,1%,1/16W,TP,1005	1.0	PC
.....3	2007-007306	R542	R-CHIP	100ohm,1%,1/16W,TP,1005	1.0	PC
.....3	2007-007306	R553	R-CHIP	100ohm,1%,1/16W,TP,1005	1.0	PC
.....3	2007-007306	R809	R-CHIP	100ohm,1%,1/16W,TP,1005	1.0	PC
.....3	2007-007306	R905	R-CHIP	100ohm,1%,1/16W,TP,1005	1.0	PC
.....3	2007-007306	R906	R-CHIP	100ohm,1%,1/16W,TP,1005	1.0	PC
.....3	2007-007306	R907	R-CHIP	100ohm,1%,1/16W,TP,1005	1.0	PC
.....3	2007-007306	R908	R-CHIP	100ohm,1%,1/16W,TP,1005	1.0	PC
.....3	2007-007306	R909	R-CHIP	100ohm,1%,1/16W,TP,1005	1.0	PC
.....3	2007-007306	R910	R-CHIP	100ohm,1%,1/16W,TP,1005	1.0	PC
.....3	2007-007313	R401	R-CHIP	6.8Kohm,1%,1/16W,TP,1005	1.0	PC
.....3	2007-007313	R402	R-CHIP	6.8Kohm,1%,1/16W,TP,1005	1.0	PC
.....3	2007-007313	R403	R-CHIP	6.8Kohm,1%,1/16W,TP,1005	1.0	PC
.....3	2007-007318	R538	R-CHIP	1Kohm,1%,1/16W,TP,1005	1.0	PC
.....3	2007-007318	R545	R-CHIP	1Kohm,1%,1/16W,TP,1005	1.0	PC
.....3	2007-007318	R806	R-CHIP	1Kohm,1%,1/16W,TP,1005	1.0	PC
.....3	2007-007318	R901	R-CHIP	1Kohm,1%,1/16W,TP,1005	1.0	PC
.....3	2007-009922	R301	R-CHIP	300Kohm,1%,1/4W,TP,3216,T0.55	1.0	PC
.....3	2007-009922	R302	R-CHIP	300Kohm,1%,1/4W,TP,3216,T0.55	1.0	PC
.....3	2007-009922	R303	R-CHIP	300Kohm,1%,1/4W,TP,3216,T0.55	1.0	PC
.....3	2203-000257	C705	C-CER,CHIP	10nF,10%,50V,X7R,TP,1608	1.0	PC
.....3	2203-000257	C801	C-CER,CHIP	10nF,10%,50V,X7R,TP,1608	1.0	PC
.....3	2203-000438	C508	C-CER,CHIP	1nF,10%,50V,X7R,TP,1005	1.0	PC
.....3	2203-000438	C516	C-CER,CHIP	1nF,10%,50V,X7R,TP,1005	1.0	PC
.....3	2203-000438	C520	C-CER,CHIP	1nF,10%,50V,X7R,TP,1005	1.0	PC
.....3	2203-000438	C901	C-CER,CHIP	1nF,10%,50V,X7R,TP,1005	1.0	PC
.....3	2203-000440	C715	C-CER,CHIP	1nF,10%,50V,X7R,TP,1608	1.0	PC
.....3	2203-001071	C519	C-CER,CHIP	0.056nF,5%,50V,COG,TP,1608	1.0	PC
.....3	2203-001083	C711	C-CER,CHIP	0.005nF,0.1pF,50V,COG,TP,1608	1.0	PC
.....3	2203-005249	C501	C-CER,CHIP	100nF,10%,50V,X7R,TP,1608	1.0	PC
.....3	2203-005249	C513	C-CER,CHIP	100nF,10%,50V,X7R,TP,1608	1.0	PC
.....3	2203-005249	C514	C-CER,CHIP	100nF,10%,50V,X7R,TP,1608	1.0	PC
.....3	2203-005249	C702	C-CER,CHIP	100nF,10%,50V,X7R,TP,1608	1.0	PC
.....3	2203-005249	C704	C-CER,CHIP	100nF,10%,50V,X7R,TP,1608	1.0	PC
.....3	2203-005249	C710	C-CER,CHIP	100nF,10%,50V,X7R,TP,1608	1.0	PC
.....3	2203-005249	C712	C-CER,CHIP	100nF,10%,50V,X7R,TP,1608	1.0	PC
.....3	2203-005249	C713	C-CER,CHIP	100nF,10%,50V,X7R,TP,1608	1.0	PC
.....3	2203-005249	C802	C-CER,CHIP	100nF,10%,50V,X7R,TP,1608	1.0	PC
.....3	2203-005249	C803	C-CER,CHIP	100nF,10%,50V,X7R,TP,1608	1.0	PC
.....3	2203-005249	C805	C-CER,CHIP	100nF,10%,50V,X7R,TP,1608	1.0	PC
.....3	2203-005249	C806	C-CER,CHIP	100nF,10%,50V,X7R,TP,1608	1.0	PC
.....3	2203-005249	C807	C-CER,CHIP	100nF,10%,50V,X7R,TP,1608	1.0	PC
.....3	2203-006158	C401	C-CER,CHIP	100nF,10%,16V,X7R,TP,1005,T0.5	1.0	PC
.....3	2203-006158	C402	C-CER,CHIP	100nF,10%,16V,X7R,TP,1005,T0.5	1.0	PC
.....3	2203-006158	C403	C-CER,CHIP	100nF,10%,16V,X7R,TP,1005,T0.5	1.0	PC
.....3	2203-006158	C410	C-CER,CHIP	100nF,10%,16V,X7R,TP,1005,T0.5	1.0	PC
.....3	2203-006158	C411	C-CER,CHIP	100nF,10%,16V,X7R,TP,1005,T0.5	1.0	PC
.....3	2203-006158	C412	C-CER,CHIP	100nF,10%,16V,X7R,TP,1005,T0.5	1.0	PC
.....3	2203-006158	C517	C-CER,CHIP	100nF,10%,16V,X7R,TP,1005,T0.5	1.0	PC
.....3	2203-006158	C521	C-CER,CHIP	100nF,10%,16V,X7R,TP,1005,T0.5	1.0	PC
.....3	2203-006158	C522	C-CER,CHIP	100nF,10%,16V,X7R,TP,1005,T0.5	1.0	PC
.....3	2203-006158	C529	C-CER,CHIP	100nF,10%,16V,X7R,TP,1005,T0.5	1.0	PC
.....3	2203-006158	C530	C-CER,CHIP	100nF,10%,16V,X7R,TP,1005,T0.5	1.0	PC
.....3	2203-006158	C531	C-CER,CHIP	100nF,10%,16V,X7R,TP,1005,T0.5	1.0	PC
.....3	2203-006158	C533	C-CER,CHIP	100nF,10%,16V,X7R,TP,1005,T0.5	1.0	PC
.....3	2203-006158	C809	C-CER,CHIP	100nF,10%,16V,X7R,TP,1005,T0.5	1.0	PC
.....3	2203-006496	C707	C-CER,CHIP	2.2nF,10%,50V,X7R,1608	1.0	PC
.....3	2203-006960	C708	C-CER,CHIP	1000nF,10%,50V,X7R,TP,2012	1.0	PC
.....3	2203-007456	C509	C-CER,CHIP	1000nF,10%,25V,X5R,TP,1005(1106),T0.5	1.0	PC
.....3	2203-007456	C512	C-CER,CHIP	1000nF,10%,25V,X5R,TP,1005(1106),T0.5	1.0	PC
.....3	2203-007456	C515	C-CER,CHIP	1000nF,10%,25V,X5R,TP,1005(1106),T0.5	1.0	PC
.....3	2203-007456	C518	C-CER,CHIP	1000nF,10%,25V,X5R,TP,1005(1106),T0.5	1.0	PC
.....3	2203-007456	C523	C-CER,CHIP	1000nF,10%,25V,X5R,TP,1005(1106),T0.5	1.0	PC
.....3	2203-007456	C526	C-CER,CHIP	1000nF,10%,25V,X5R,TP,1005(1106),T0.5	1.0	PC
.....3	2203-007456	C528	C-CER,CHIP	1000nF,10%,25V,X5R,TP,1005(1106),T0.5	1.0	PC
.....3	2203-007456	C551	C-CER,CHIP	1000nF,10%,25V,X5R,TP,1005(1106),T0.5	1.0	PC
.....3	2203-007456	C552	C-CER,CHIP	1000nF,10%,25V,X5R,TP,1005(1106),T0.5	1.0	PC
.....3	2203-007456	C808	C-CER,CHIP	1000nF,10%,25V,X5R,TP,1005(1106),T0.5	1.0	PC
.....3	2203-007486	C804	C-CER,CHIP	1000nF,10%,50V,X5R,TP,1608	1.0	PC
.....3	2402-000120	C706	C-AL,SMD	10UF,20%,50V,GP,TP,6.6X6.6X5.4MM	1.0	PC
.....3	2402-001145	C701	C-AL,SMD	47uF,20%,50V,GP,TP,6.3X7.7mm	1.0	PC
.....3	2402-001145	C703	C-AL,SMD	47uF,20%,50V,GP,TP,6.3X7.7mm	1.0	PC
.....3	2802-001211	X501	RESONATOR-CERAMIC	8MHz,0.5%,TP,3.2x1.3x0.9 mm	1.0	PC
.....3	DB41-01362A	PCB MAIN	PCB MAIN	FR-4,2Layer,T1.6,120*98,4,WIND FREE, A-STD#4, BLDC MOTOR	1.0	PC
.....3	DB91-01934A	IC04	ASSY MICOM	18K_RAC_Windfree_Inv,STM-1750-OA,HART-m310,100MQFP	1.0	PC
.....4	0903-001864	IC04	IC-MICROCONTROLLER	HART-M310,QFP,100P,20x14mm,8MHz,5V,600mW,-40to+85C	1.0	PC

## 6. Electrical Parts List

### 6-2 OUTDOOR MAIN PCB(DB92-04029E)

Level	Parts Code	Parts Description	Spec.	Quantity	Unit
..1	0204-005754	COATING	SL 1301 ECO,55±5s,colorless	0.0040	PC
..1	DB68-05458A	LABEL BAR CODE	AM9000H,ART,W17.5,L18	1.0	PC
..1	DB94-07429A	ASSY PCB MANUAL	Main PBA,RAC,DB92-04029E	1.0	PC
....2	0201-002354	ADHESIVE-COM	1-2577,Translucent,950	0.0010	KG
....2	0202-001463	SOLDER-WIRE	LFC2-W3.0,D3,99.79Sn/0.2Cu/0.01P,No Flux	6.0	G
....2	0202-001608	SOLDER-WIRE FLUX	LFC7-107,D0.8,99.3Sn/0.7Cu/0.01P,Flux 3.5%	0.2	G
....2	0204-004665	FLUX	KSP-70M-S,MIXTURE,NO,FLUX,13%	3.0	G
....2	2301-001935	C-FILM,LEAD	22nF,20%,300V,BK,18x7x13.5mm	1.0	PC
....2	2301-001935	C-FILM,LEAD	22nF,20%,300V,BK,18x7x13.5mm	1.0	PC
....2	2301-001935	C-FILM,LEAD	22nF,20%,300V,BK,18x7x13.5mm	1.0	PC
....2	2301-001935	C-FILM,LEAD	22nF,20%,300V,BK,18x7x13.5mm	1.0	PC
....2	3711-000012	HEADER-BOARD TO CABLE	BOX,4P,1R,2.5MM,STRAIGHT,SN,WHT	1.0	PC
....2	3711-000177	HEADER-BOARD TO CABLE	1WALL,2P,1R,3.96MM,STRAIGHT,SN,RED	1.0	PC
....2	3711-000999	HEADER-BOARD TO CABLE	BOX,5P,1R,2.5mm,STRAIGHT,SN,WHT,5.8x14.9x7.0mm	1.0	PC
....2	3711-001084	HEADER-BOARD TO CABLE	BOX,8P,1R,2.5mm,STRAIGHT,SN,WHT,5.8x22.4x7	1.0	PC
....2	3711-002001	HEADER-BOARD TO CABLE	BOX,20P,2R,2.0mm,STRAIGHT,SN,BLK,5.0X22.0X6.6mm	1.0	PC
....2	3711-003846	HEADER-BOARD TO CABLE	BOX,8P,1R,2mm,ANGLE,SN,WHT	1.0	PC
....2	3711-006337	CONNECTOR-HEADER	BOX,5P,1R,2.5mm,ANGLE,SN,RED	1.0	PC
....2	3711-007817	HEADER-BOARD TO BOARD	3WALL,7P,1R,2mm,STRAIGHT,SN,WHT	1.0	PC
....2	3712-001047	CONNECTOR-TERMINAL	TAB,MALE,N,0.5/4.75mm	1.0	PC
....2	DB27-00082A	COIL CHOKE	40mH,0.5A,8.4x3.4,Mn-Zn	1.0	PC
....2	DB27-00090A	COIL CHOKE	31uH,13*15	1.0	PC
....2	DB68-05458A	LABEL BAR CODE	AM9000H,ART,W17.5,L18	1.0	PC
....2	DB94-07428A	ASSY PCB AUTO	Main PBA,RAC,DB92-04029E	1.0	PC
.....3	1404-001194	THERMISTOR-PTC	39ohm,20%,220/240V,270Vac,1.2A,TP	1.0	PC
.....3	DB27-00034A	BEAD-AXIAL	55ohm,5.7x3.5mm,TP,55ohm/100MHz	1.0	PC
.....3	DB94-07430A	ASSY PCB SMD	Main PBA,RAC,DB92-04029E	1.0	PC
.....4	0202-001933	SOLDER-CREAM	LFM-48W TM-HP,D20~38um,96.5Sn/3Ag/0.5Cu,Flux 12%	1.0	G
.....4	0406-001204	DIODE-TVS	SMBJ5.0CA,6.4/-7.25V,600W,SMB	1.0	PC
.....4	0406-001204	DIODE-TVS	SMBJ5.0CA,6.4/-7.25V,600W,SMB	1.0	PC
.....4	0406-001204	DIODE-TVS	SMBJ5.0CA,6.4/-7.25V,600W,SMB	1.0	PC
.....4	0506-000175	TR-ARRAY	2003,NPN,7,1000mW,SOP-16,TP,1000	1.0	PC
.....4	0601-002345	LED	SMD,RED,1.6x0.8x0.55mm,660nm,1.6x0.8x0.55mm	1.0	PC
.....4	0601-002419	LED	SMD(TOP VIEW),YEL,1.6x0.8mm,591nm,1.6x0.8x0.6mm	1.0	PC
.....4	0601-002679	LED	SMD(TOP VIEW),Y-GRN,1.6x0.8mm,573nm,1.6x0.8x0.6mm	1.0	PC
.....4	0801-000393	IC-CMOS LOGIC	74HC86,OR GATE,SOP,14P,150ML,QUAD,TP,2.0/6.0V	1.0	PC
.....4	1006-001325	IC-BUS TRANSCEIVER	SO,8P,4.9x3.8 mm,SINGLE,ST,PLASTIC,5V,-40to+85C	1.0	PC
.....4	1203-006245	IC-VOL. DETECTOR	KIA7033AT,TSM,3P,2.9x1.6x0.7mm,PLASTIC,3.3V,350mW	1.0	PC
.....4	2007-000116	R-CHIP	120ohm,5%,1/10W,TP,1608	1.0	PC
.....4	2007-000148	R-CHIP	10Kohm,5%,1/16W,TP,1005	1.0	PC
.....4	2007-000148	R-CHIP	10Kohm,5%,1/16W,TP,1005	1.0	PC
.....4	2007-000148	R-CHIP	10Kohm,5%,1/16W,TP,1005	1.0	PC
.....4	2007-000148	R-CHIP	10Kohm,5%,1/16W,TP,1005	1.0	PC
.....4	2007-000148	R-CHIP	10Kohm,5%,1/16W,TP,1005	1.0	PC
.....4	2007-000148	R-CHIP	10Kohm,5%,1/16W,TP,1005	1.0	PC
.....4	2007-000148	R-CHIP	10Kohm,5%,1/16W,TP,1005	1.0	PC
.....4	2007-000148	R-CHIP	10Kohm,5%,1/16W,TP,1005	1.0	PC
.....4	2007-000148	R-CHIP	10Kohm,5%,1/16W,TP,1005	1.0	PC
.....4	2007-000148	R-CHIP	10Kohm,5%,1/16W,TP,1005	1.0	PC
.....4	2007-000148	R-CHIP	10Kohm,5%,1/16W,TP,1005	1.0	PC
.....4	2007-000148	R-CHIP	10Kohm,5%,1/16W,TP,1005	1.0	PC
.....4	2007-000148	R-CHIP	10Kohm,5%,1/16W,TP,1005	1.0	PC
.....4	2007-000148	R-CHIP	10Kohm,5%,1/16W,TP,1005	1.0	PC
.....4	2007-000148	R-CHIP	10Kohm,5%,1/16W,TP,1005	1.0	PC



## 6. Electrical Parts List

### 6-2 OUTDOOR MAIN PCB

Level	Parts Code	Parts Description	Spec.	Quantity	Unit
.....4	2007-007306	R-CHIP	100ohm,1%,1/16W,TP,1005	1.0	PC
.....4	2007-007306	R-CHIP	100ohm,1%,1/16W,TP,1005	1.0	PC
.....4	2007-007306	R-CHIP	100ohm,1%,1/16W,TP,1005	1.0	PC
.....4	2007-007306	R-CHIP	100ohm,1%,1/16W,TP,1005	1.0	PC
.....4	2007-007306	R-CHIP	100ohm,1%,1/16W,TP,1005	1.0	PC
.....4	2007-007306	R-CHIP	100ohm,1%,1/16W,TP,1005	1.0	PC
.....4	2007-007306	R-CHIP	100ohm,1%,1/16W,TP,1005	1.0	PC
.....4	2007-007306	R-CHIP	100ohm,1%,1/16W,TP,1005	1.0	PC
.....4	2007-007306	R-CHIP	100ohm,1%,1/16W,TP,1005	1.0	PC
.....4	2007-007306	R-CHIP	100ohm,1%,1/16W,TP,1005	1.0	PC
.....4	2007-007306	R-CHIP	100ohm,1%,1/16W,TP,1005	1.0	PC
.....4	2007-007306	R-CHIP	100ohm,1%,1/16W,TP,1005	1.0	PC
.....4	2007-007306	R-CHIP	100ohm,1%,1/16W,TP,1005	1.0	PC
.....4	2007-007306	R-CHIP	100ohm,1%,1/16W,TP,1005	1.0	PC
.....4	2007-007306	R-CHIP	100ohm,1%,1/16W,TP,1005	1.0	PC
.....4	2007-007318	R-CHIP	1Kohm,1%,1/16W,TP,1005	1.0	PC
.....4	2007-007318	R-CHIP	1Kohm,1%,1/16W,TP,1005	1.0	PC
.....4	2007-007318	R-CHIP	1Kohm,1%,1/16W,TP,1005	1.0	PC
.....4	2007-007942	R-CHIP	1Mohm,1%,1/16W,TP,1005	1.0	PC
.....4	2203-000438	C-CER,CHIP	1nF,10%,50V,X7R,TP,1005	1.0	PC
.....4	2203-000438	C-CER,CHIP	1nF,10%,50V,X7R,TP,1005	1.0	PC
.....4	2203-000438	C-CER,CHIP	1nF,10%,50V,X7R,TP,1005	1.0	PC
.....4	2203-000438	C-CER,CHIP	1nF,10%,50V,X7R,TP,1005	1.0	PC
.....4	2203-000438	C-CER,CHIP	1nF,10%,50V,X7R,TP,1005	1.0	PC
.....4	2203-000438	C-CER,CHIP	1nF,10%,50V,X7R,TP,1005	1.0	PC
.....4	2203-001071	C-CER,CHIP	0.056nF,5%,50V,COG,TP,1608	1.0	PC
.....4	2203-002285	C-CER,CHIP	10nF,10%,50V,X7R,TP,1005	1.0	PC
.....4	2203-002285	C-CER,CHIP	10nF,10%,50V,X7R,TP,1005	1.0	PC
.....4	2203-005249	C-CER,CHIP	100nF,10%,50V,X7R,TP,1608	1.0	PC
.....4	2203-005249	C-CER,CHIP	100nF,10%,50V,X7R,TP,1608	1.0	PC
.....4	2203-005249	C-CER,CHIP	100nF,10%,50V,X7R,TP,1608	1.0	PC
.....4	2203-005249	C-CER,CHIP	100nF,10%,50V,X7R,TP,1608	1.0	PC
.....4	2203-005249	C-CER,CHIP	100nF,10%,50V,X7R,TP,1608	1.0	PC
.....4	2203-005249	C-CER,CHIP	100nF,10%,50V,X7R,TP,1608	1.0	PC
.....4	2203-006158	C-CER,CHIP	100nF,10%,16V,X7R,TP,1005,T0.5	1.0	PC
.....4	2203-006158	C-CER,CHIP	100nF,10%,16V,X7R,TP,1005,T0.5	1.0	PC
.....4	2203-006158	C-CER,CHIP	100nF,10%,16V,X7R,TP,1005,T0.5	1.0	PC
.....4	2203-006158	C-CER,CHIP	100nF,10%,16V,X7R,TP,1005,T0.5	1.0	PC
.....4	2203-006158	C-CER,CHIP	100nF,10%,16V,X7R,TP,1005,T0.5	1.0	PC
.....4	2203-006158	C-CER,CHIP	100nF,10%,16V,X7R,TP,1005,T0.5	1.0	PC
.....4	2203-006158	C-CER,CHIP	100nF,10%,16V,X7R,TP,1005,T0.5	1.0	PC
.....4	2203-006158	C-CER,CHIP	100nF,10%,16V,X7R,TP,1005,T0.5	1.0	PC
.....4	2203-006158	C-CER,CHIP	100nF,10%,16V,X7R,TP,1005,T0.5	1.0	PC
.....4	2203-006158	C-CER,CHIP	100nF,10%,16V,X7R,TP,1005,T0.5	1.0	PC
.....4	2203-006158	C-CER,CHIP	100nF,10%,16V,X7R,TP,1005,T0.5	1.0	PC
.....4	2203-006158	C-CER,CHIP	100nF,10%,16V,X7R,TP,1005,T0.5	1.0	PC
.....4	2203-006158	C-CER,CHIP	100nF,10%,16V,X7R,TP,1005,T0.5	1.0	PC
.....4	2203-006158	C-CER,CHIP	100nF,10%,16V,X7R,TP,1005,T0.5	1.0	PC
.....4	2203-006158	C-CER,CHIP	100nF,10%,16V,X7R,TP,1005,T0.5	1.0	PC
.....4	2203-007306	C-CER,CHIP	10000nF,10%,25V,X5R,TP,2012,T1.25	1.0	PC
.....4	2203-007306	C-CER,CHIP	10000nF,10%,25V,X5R,TP,2012,T1.25	1.0	PC
.....4	2203-007456	C-CER,CHIP	1000nF,10%,25V,X5R,TP,1005,T0.5	1.0	PC
.....4	2203-007456	C-CER,CHIP	1000nF,10%,25V,X5R,TP,1005,T0.5	1.0	PC
.....4	2203-007456	C-CER,CHIP	1000nF,10%,25V,X5R,TP,1005,T0.5	1.0	PC
.....4	2203-007456	C-CER,CHIP	1000nF,10%,25V,X5R,TP,1005,T0.5	1.0	PC
.....4	2203-007456	C-CER,CHIP	1000nF,10%,25V,X5R,TP,1005,T0.5	1.0	PC
.....4	2203-007456	C-CER,CHIP	1000nF,10%,25V,X5R,TP,1005,T0.5	1.0	PC
.....4	2203-007456	C-CER,CHIP	1000nF,10%,25V,X5R,TP,1005,T0.5	1.0	PC
.....4	2203-007456	C-CER,CHIP	1000nF,10%,25V,X5R,TP,1005,T0.5	1.0	PC
.....4	2203-007456	C-CER,CHIP	1000nF,10%,25V,X5R,TP,1005,T0.5	1.0	PC
.....4	2203-007456	C-CER,CHIP	1000nF,10%,25V,X5R,TP,1005,T0.5	1.0	PC
.....4	2802-001211	RESONATOR-CERAMIC	8MHz,0.5%,TP,3.2x1.3x0.9 mm	1.0	PC
.....4	DB41-01352A	PCB MAIN	FR-4,2Layer,T1.6,142*48.5,8,RAC_OUT_MAIN,10z,284*194	1.0	PC
.....4	DB91-01949A	ASSY MICOM	18K_RAC_PFB2_SG_OUT_NORDIC,STM-1760-OA	1.0	PC
.....5	0903-001864	IC-MICROCONTROLLER	HART-M310,QFP,100P,20x14mm,8MHz,5V,600mW	1.0	PC



# 7-1 Indoor Unit

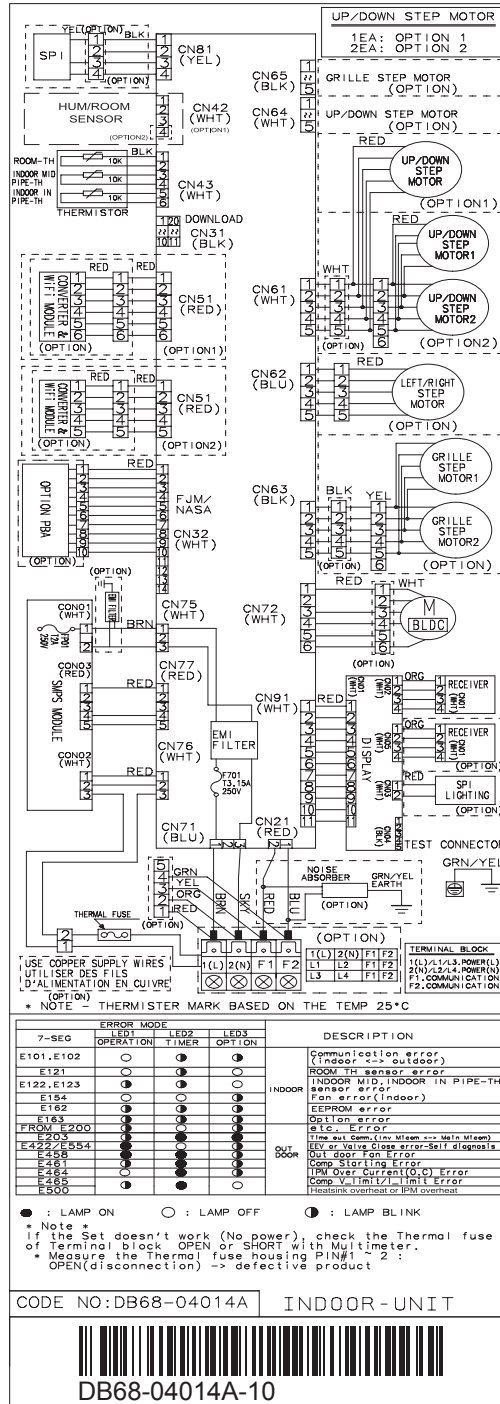

# 7-2 Outdoor Unit

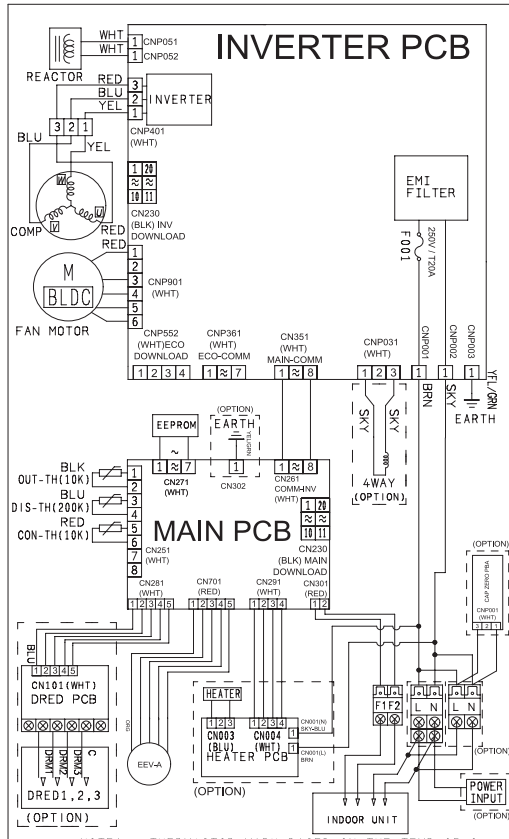

※ NOTE1 - THERMISTOR MARK BASED ON THE TEMP 25°C

LED PATTERN	7SEG	DISPLAY	DESCRIPTION
● ○ ○	-	-	POWER OFF / VDD NG
● ● ○	-	-	Power ON reset(1sec)
○ ○ ●	-	-	NORMAL OPERATION
○ ○ ●	-	-	Abnormal Communication (Indoor<->Outdoor)
○ ○ ●	E464	IPM	IPM Over Current(O.C) Error
○ ○ ●	E461	Comp	Comp Starting Error
○ ○ ●	E470	EEPROM	EEPROM Data Error (no data)
○ ○ ●	E466	DC-Link	DC-Link Voltage Under/Over Error
○ ○ ●	E464	PFC	PFC Over Load Error
○ ○ ●	E483	Over Voltage	Over Voltage Protection Error
○ ○ ●	E221	OUT-TH	OUT-TH(Outdoor Temperature) Sensor Error
○ ○ ●	E416	DIS-TH	DIS-TH(Discharge Temperature) Over Error
○ ○ ●	E251	DIS-TH	DIS-TH(Discharge Temperature) Sensor Error
○ ○ ●	E468	Current	Current Sensor Error
○ ○ ●	E474	Heatsink	Heatsink Sensor Error
○ ○ ●	E485	Input Current	Input Current Sensor Error
○ ○ ●	E465	Comp V.Limit	Comp V.Limit/Limit Error
○ ○ ●	E500	Heatsink	Heatsink Over Temperature Error
○ ○ ●	E231	CON-TH	CON-TH(Cond Temperature) Sensor Error
○ ○ ●	E203	Time out	Time out Comm. (Inv Micom->Main Micom)
○ ○ ●	E458	Fan	Fan Error
○ ○ ●	E471	EEPROM	EEPROM Data Error (Main Micom->Inv Micom)
○ ○ ●	E467	Comp Wire	Comp Wire Missing Error
○ ○ ●	E440	Prohibit	Prohibit Operation Condition Error (Heating)
○ ○ ●	E441	Prohibit	Prohibit Operation Condition Error (Cooling)
○ ○ ●	E469	DC-Link	DC-Link Voltage Sensor Error
○ ○ ●	E488	AC Input	AC Input Voltage Sensor Error
○ ○ ●	E462	AC Input	AC Input I-Limit Trip Error
○ ○ ●	E554	Gas Leak	Gas Leak Error
○ ○ ●	E422	EEV or Valve	EEV or Valve Close error-Self diagnosis
○ ○ ●	-	-	Test Operation at Cooling Mode
○ ○ ●	-	-	Test Operation at Heating Mode

● LED ON ○ LED OFF ◎ LED BLINKING  
DB68-06674A OUTDOOR UNIT



DB68-06674A-1

# 8. Schematic Diagram

## 8-1 Indoor Unit

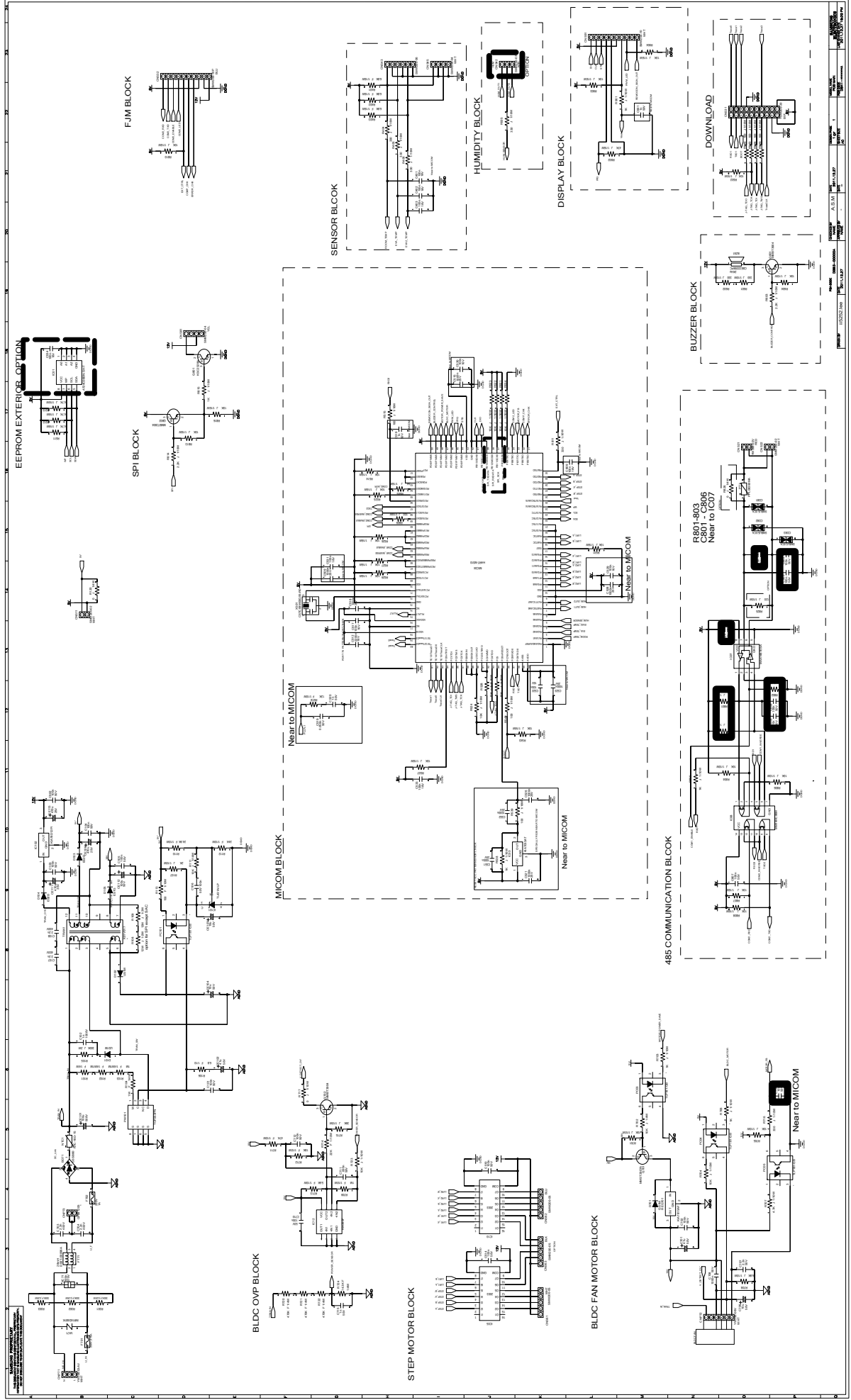

# 8-2 Outdoor Unit

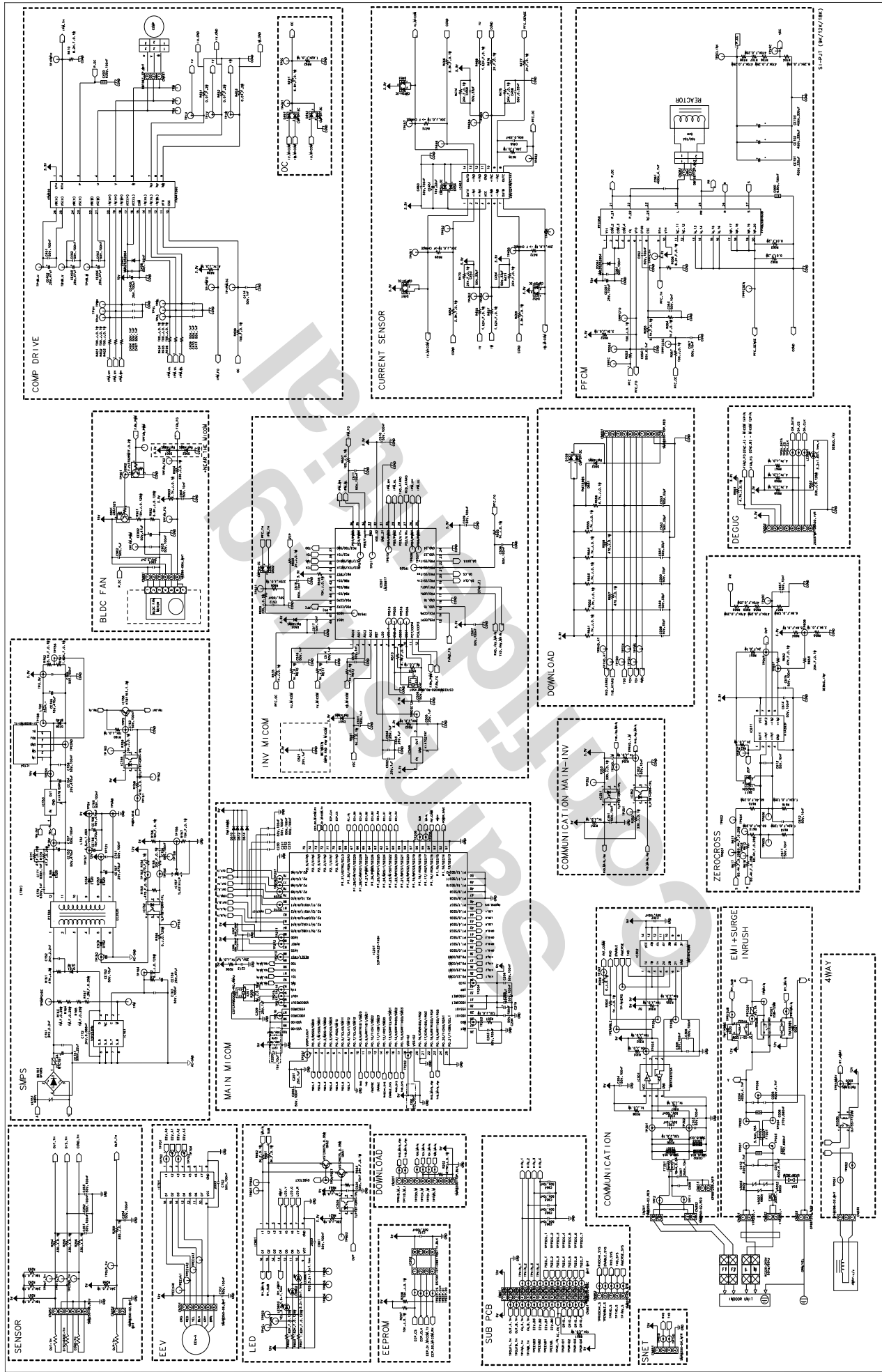

This Document can not be used without Samsung's authorization.

### 8-3 Refrigerating Cycle Diagram

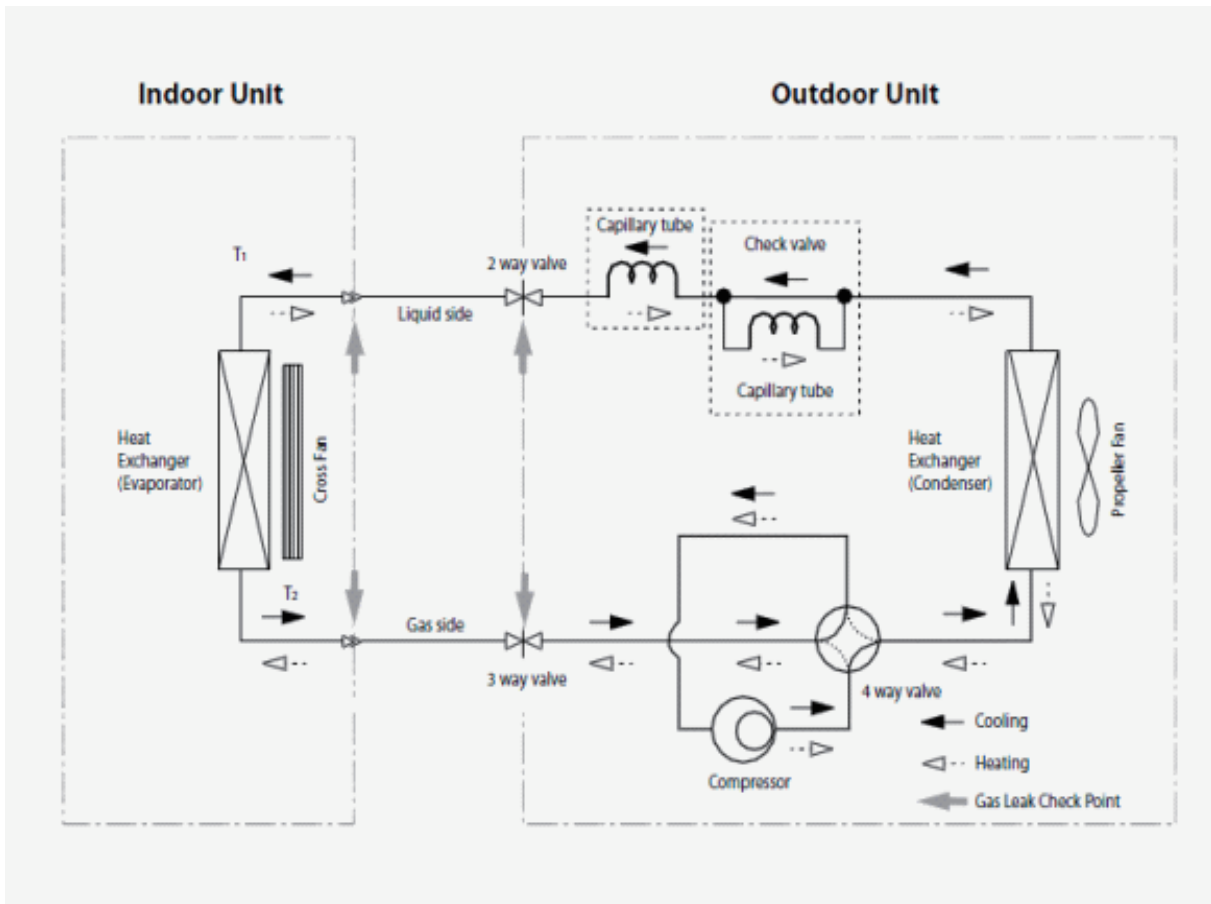

## 8-4 Indoor Main PCB\_DB92-04101B

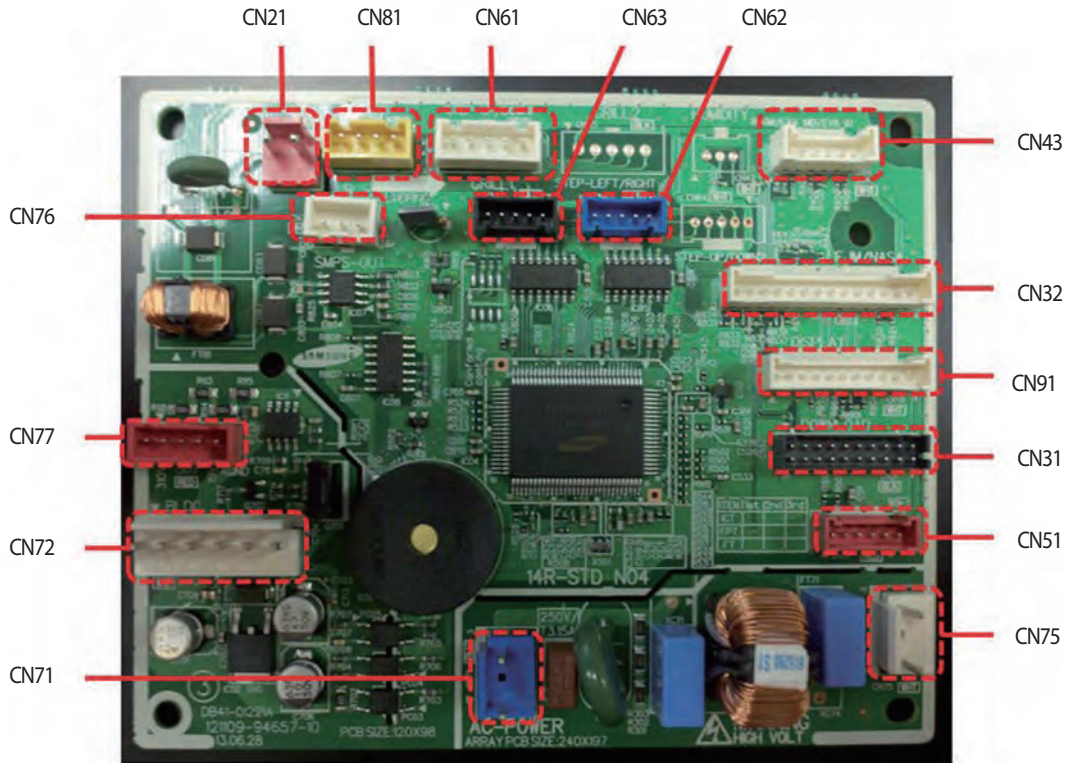

<p>① <b>CN61/CN62/CN63 - STEP MOTOR</b></p> <p>#1:DC 12V #2~#5:STEP MOTOR SIGNAL</p>	<p>② <b>CN71 - POWER IN</b></p> <p>#1,#3: AC220~240V #2:N.C</p>	<p>③ <b>CN81 - SPI</b></p> <p>#1:SPI SIGNAL #3:DC 12V</p>	<p>④ <b>CN51 - WI-FI MODULE</b></p> <p>#1: WIFI UART SIGNAL1 #2: WIFI UART SIGNAL2 #3: WIFI RESET SIGNAL #4: GND #5: DC 12V #6: N.C</p>
<p>⑤ <b>CN51 - DISPLAY</b></p> <p>#1~#11,#14,#17~#20: MICOM DOWN #12, #13, #15, #16: N.C</p>	<p>⑥ <b>CN43 - TEMPERATURE SENSOR</b></p> <p>#1,#2: ROOM SENSOR #3,#4: EVA MID SENSOR #5,#6: EVA IN SENSOR</p>	<p>⑦ <b>CN21 - COMMUNICATION</b></p> <p>#1,#2: 485 COMM SIGNAL</p>	<p>⑧ <b>CN72 - BLDC FAN MOTOR</b></p> <p>#1: DC 310~340V #2: N.C #3: AGND #4: DC 15V #5: FAN RPM #6: FAN FEEDBACK</p>
<p>⑨ <b>CN32 - FJM/NASA</b></p> <p>#1~#7, #11~ #14: FJM/NASA SIGNAL #8: DC 5V #9: GND #10: DC 12V</p>	<p>⑩ <b>CN75 - SMPS POWER IN</b></p> <p>#1,#3: AC220~240V #2: N.C</p>	<p>⑪ <b>CN76 - SMPS DC OUT (12V/GND/5V)</b></p> <p>#1: DC 5V #2: GND #3: DC 12V</p>	<p>⑫ <b>CN77 - SMPS DC OUT (19V/GND/310V)</b></p> <p>#1: DC 310V~340V #2,#3: N.C #4: DC 19V~27V #5: AGND</p>
<p>⑬ <b>CN31 - DOWNLOAD</b></p> <p>DOWNLOAD</p>			



## 8-5 Outdoor INVERTER PCB(DB92-04025D)

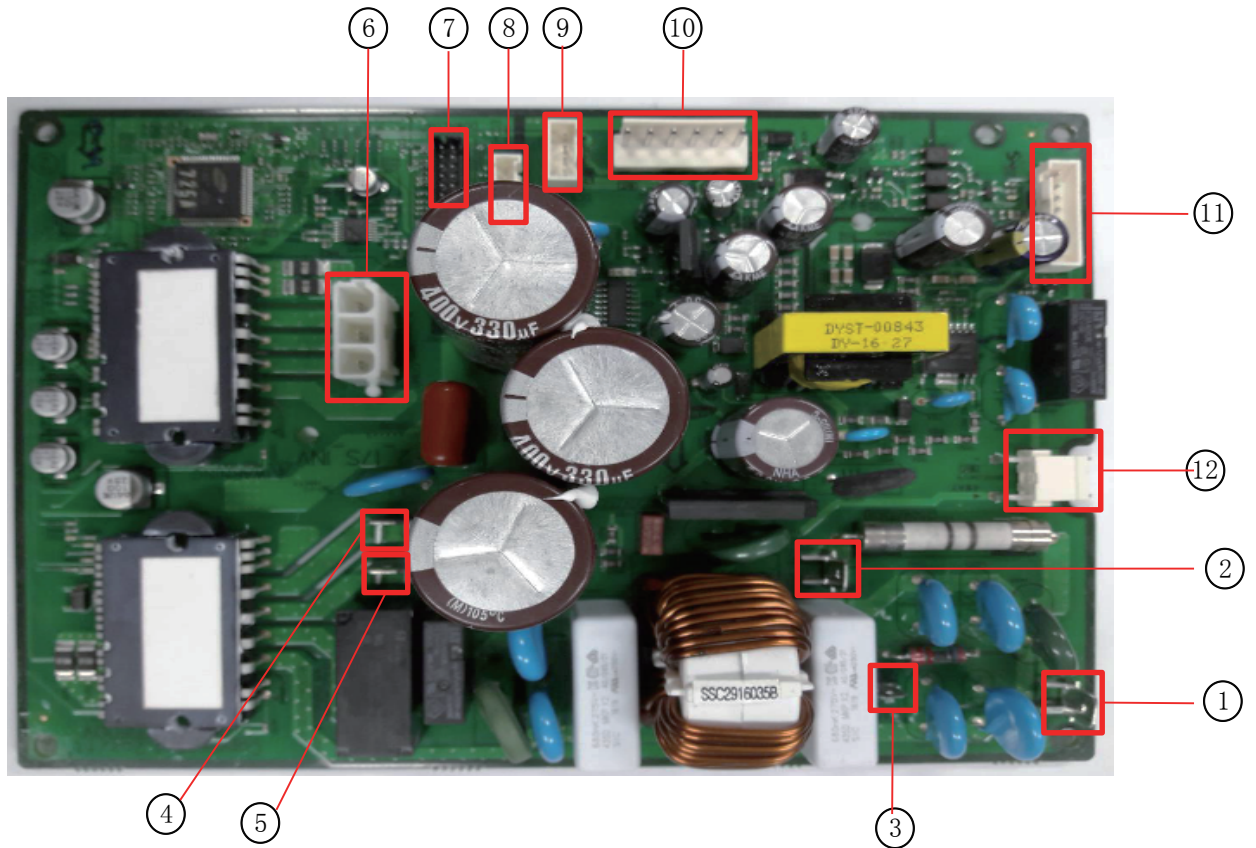

① <b>CNP001 : POWER N</b>	② <b>CNP002 : POWER L</b>	③ <b>CNP003 : POWER EARTH</b>	④ <b>CNP052 : REACTOR</b>
⑤ <b>CNP051 : REACTOR</b>	⑥ <b>CNP401 : COMP</b> #1 : W phase #2 : V phase #3 : U phase	⑦ <b>CN203 : INV DOWNLOAD</b> Inv PBA S/W Download	⑧ <b>CNP361 : ECO-COMM</b>
⑨ <b>CNP552</b>	⑩ <b>CNP901 : BLDC FAN</b> #1 : DC310V #3 : 15V #4 : PGND #5 : BLDC FAN POWER SAVE #6 : BLDC FAN Feedback	⑪ <b>CN351 : MAIN-INV COMM</b> #1 : INV_RXD-MAIN_TXD #2 : INV_TXD-MAIN_RXD #3 : 5V #4 : SGND #5 : 12V #6 : Power save #7 : 4WAY singal	⑫ <b>CNP031 : 4-WAY</b>

## 8-5 Outdoor PCB MAIN (DB92-04029E)

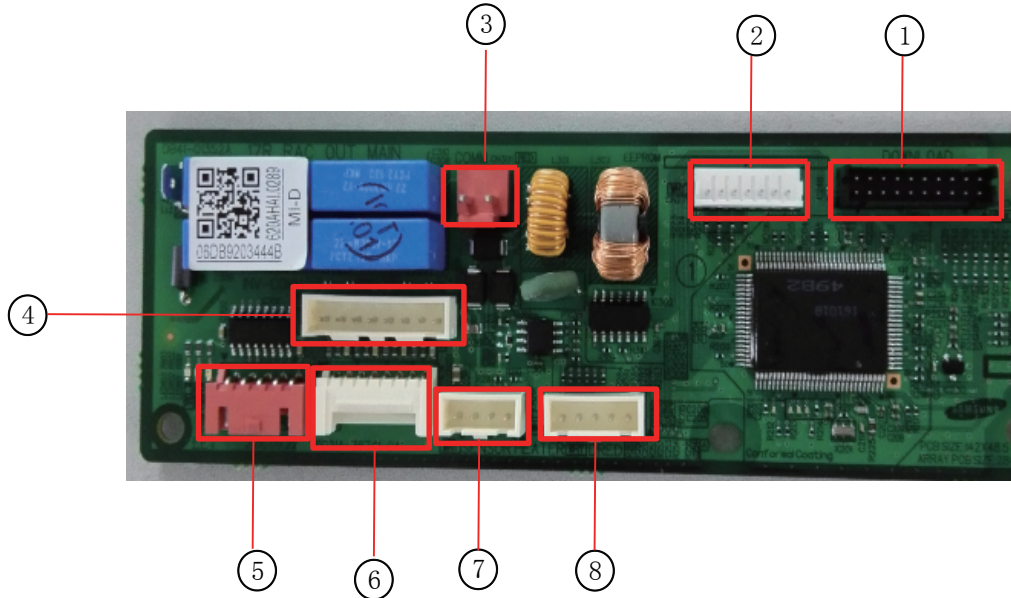

<p>① <b>CN230 : DOWNLOAD</b> : Main PBA S/W Download</p>	<p>② <b>CN271 : EEPROM</b></p>	<p>③ <b>CN301 : 485 COMM</b> #1 : F1 #2 : F2</p>	<p>④ <b>CN261 : MAIN-INV COMM</b> #1 : INV_TXD-MAIN_RXD #2 : INV_RXD-MAIN_TXD #3 : 5V #4 : SGND #5 : 12V #6 : Power save #7 : 4WAY singal</p>
<p>⑤ <b>CN701 : EEV-A</b></p>	<p>⑥ <b>CN251 : SENSOR</b> #1-#2 : OUTDOOR_TEMP #3-#4 : DISCHARGE_TEMP #5-#6 : COND_TEMP #7-#8 : OLP_TEMP</p>	<p>⑦ <b>CN291 : HEATER(OPTION)</b> #1:12V #2:SGND #3:Heater L #4:Heater N</p>	<p>⑧ <b>CN281 : DRED(OPTION)</b> #1 : DRED1 signal #2 : DRED2 signal #3 : DRED3 signal #4 : SGND #4 : 5V</p>



## 8-6. Wire connecting the indoor unit terminal blocks

---

1. Terminal press of Ring terminal shall be set facing up before connecting wire.



Is inverted

Terminal has been cut.

2. There shall be no empty space between Ring terminal and Screw after Clamp.  
If not, there exists a possibility of fire which can be caused by electric heat in the connecting part.

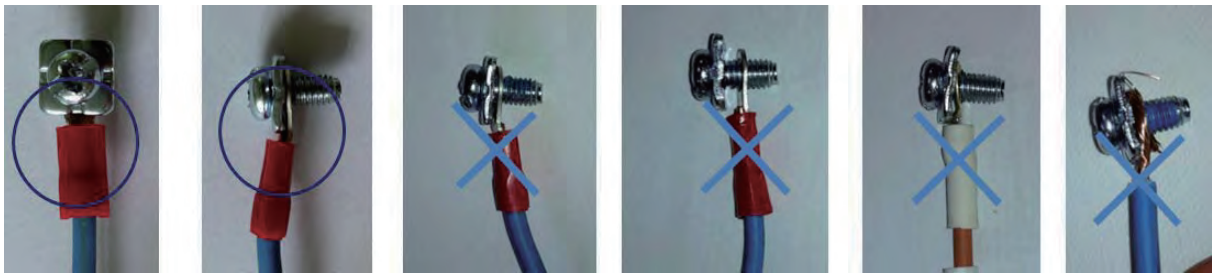

①

②

③

④

⑤

⑥

- ①, ② : Good  
③ Bad : Ring terminal is connected reversely  
④ Bad : Not clamped Screw  
⑤ Bad : In the gap between Ring terminal & Screw  
⑥ Bad : Unused Ring Terminal

## 9. Operating Instructions

### 9-1 Name of Each Part

#### 9-1-1 Indoor Unit

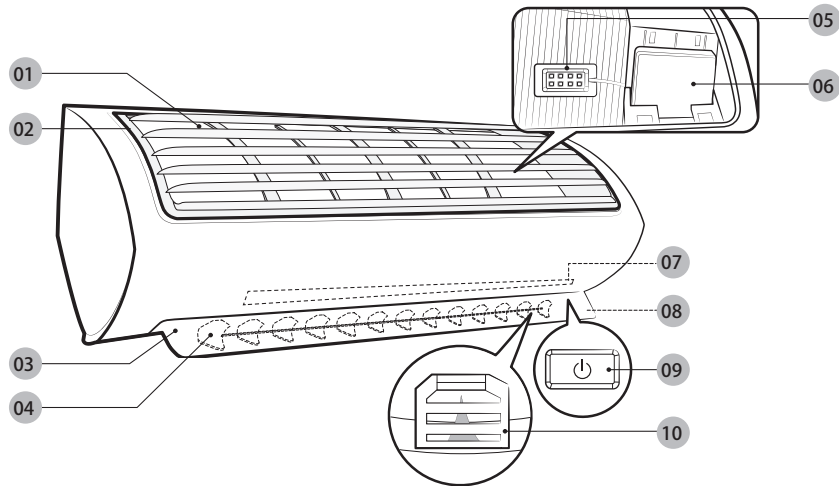

- |                                    |  |
|------------------------------------|--|
| 01 Air intake                      | 06 Wi-Fi module                              |
| 02 Air filter                      | 07 SPI(S-plasma Ion) Lamp                    |
| 03 Air flow blade (up and down)    | 08 Display                                   |
| 04 Air flow blade (left and right) | 09 Power button /<br>Remote control receiver |
| 05 Room temperature sensor         | 10 (Inside) SPi                              |

#### Display

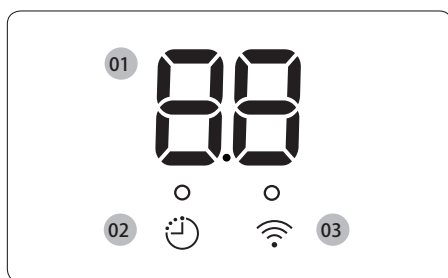

- |    |   |
|----|---|
| 01 | Temperature indicator<br>Filter reset indicator ( [ F )<br>Electricity consumption indicator<br>Auto clean indicator ( [ ! )<br>Defrost indicator ( d F ) |
| 02 | Timer indicator<br>good'sleep indicator<br>Auto clean indicator   |
| 03 | Wi-Fi indicator   |

## 9-1-2 Outdoor Unit

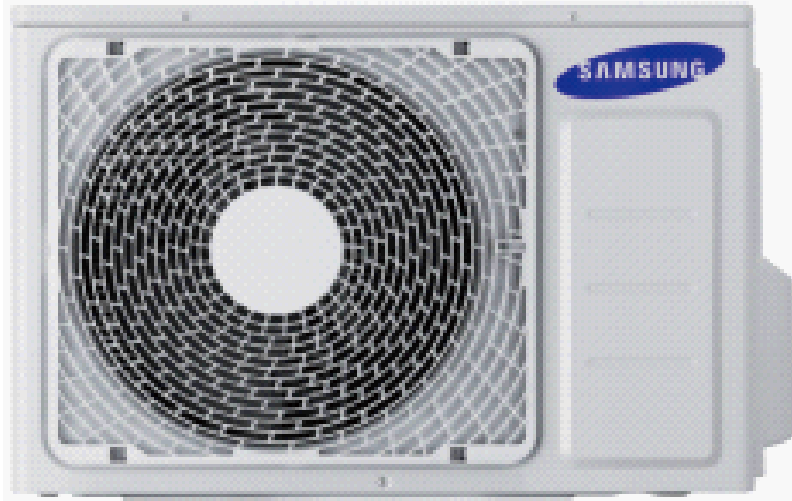

## 9-2 Wireless Remote Control-Buttons and Display

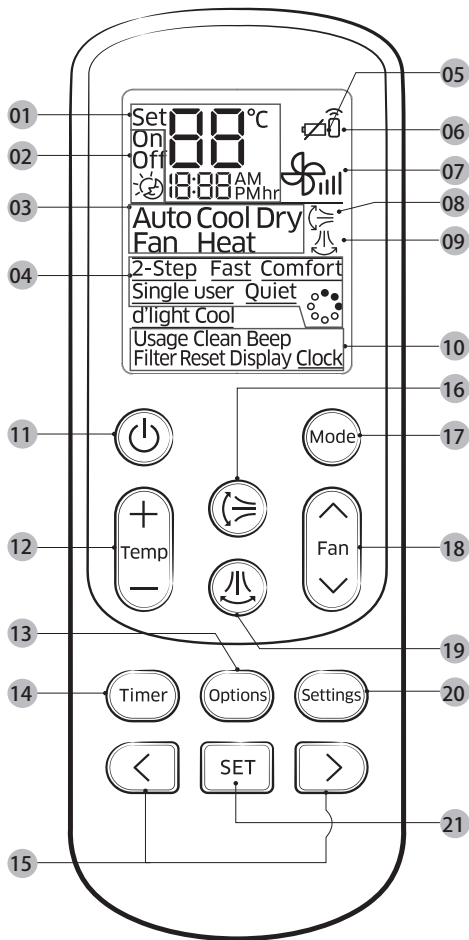

- 01 Set temperature indicator
- 02 Timer option indicator
- 03 Operation mode indicator
- 04 Options indicator
- 05 Low battery indicator
- 06 Transmit indicator
- 07 Fan speed indicator
- 08 Vertical air swing indicator
- 09 Horizontal air swing indicator
- 10 Settings indicator
- 11 Power button
- 12 Temperature button
- 13 Options button
- 14 Timer button
- 15 Direction button / Selection button
- 16 Vertical air swing button
- 17 Mode button
- 18 Fan speed button
- 19 Horizontal air swing button
- 20 Settings button
- 21 SET button

### Inserting batteries

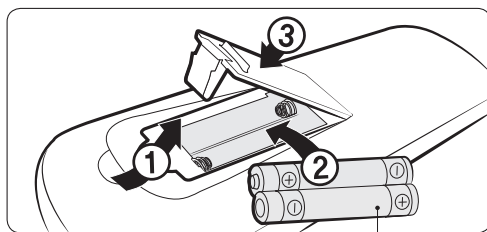

two 1.5V AAA type batteries



#### NOTE

- The descriptions in this manual are primarily made based on the remote control buttons.
- Although d'light Cool are displayed on the remote control display, they are not available on this model.

# 10. Troubleshooting

## 10-1 Items to be checked first

- The input voltage should be rating voltage  $\pm 10\%$  range.  
The air conditioner may not operate properly if the voltage is out of this range.
- Is the line cable linking the indoor unit and the outdoor unit linked properly?  
The indoor unit and the outdoor unit shall be linked by 5 cables.  
Check the terminals if the indoor unit and outdoor unit are properly linked by the same number of cables.  
Otherwise the air conditioner may not operate properly.
- When a problem occurs due to the contents illustrated in the table below it is a symptom not related to the malfunction of the air conditioner.

NO	Operation of air conditioner	Explanation
1	The OPERATION indication LED(BLUE) blinks when a power plug of the indoor unit is plugged in for first time.	It indicates power is on. The LED stops blinking if the operation ON/OFF button on the remote control unit is pushed.
2	In a COOL operation mode, the compressor does not operate at a room temperature higher than the setting temperature that the INDOOR FAN should operate. <b>[ In case of heat pump model ]</b> In a HEAT operation mode, the compressor does not operate at a room temperature lower than the setting temperature that indoor fan should operate.	In happens after a delay of 3 minutes when the compressor is reoperated. The same phenomenon occurs when a power is on. As a phenomenon that the compressor is reoperated after a delay of 3 minutes, the indoor fan is adjusted automatically with reference to a temperature of the air blew.
3	Fan speed setting is not allowed in DRY  mode.	The speed of the indoor fan is set to LL in DRY mode. Fan speed is selected automatically in AUTO mode.
4	Compressor stops operation intermittently in Dry  mode.	Compressor operation is controlled automatically in DRY mode depending on the room temperature and humidity.
5	Timer LED(ORANGE) of the indoor unit lights up and the air conditioner does not operate.	Timer is being activated and the unit is in ready mode. The unit operates normally if the timer operation is cancelled.
6	The compressor stops intermittently in a COOL mode or DRY mode, and fan speed of the indoor unit decreases.	The compressor stops intermittently or the fan speed of the indoor unit decreases to prevent inside/outside air frozen depending on the inside/outside air temperature.
7	<b>[In case of heat pump model]</b> Compressor of the outdoor unit is operating although it is turned off in a HEAT mode.	When the unit is turned off while de-ice is activated, the compressor continues operation for up to 9 minutes(maximum) until the deice is completed.
8	<b>[In case of heat pump model]</b> The compressor and indoor fan stop intermittently in HEAT mode.	The compressor and indoor fan stop intermittently if room temperature exceeds a setting temperature in order to protect the compressor from overheated air in a HEAT mode.
9	<b>[In case of heat pump model]</b> Indoor fan and outdoor fan stop operation intermittently in a HEAT mode.	The compressor operates in a reverse cycle to remove exterior ice in a HEAT mode, and indoor fan and outdoor fan do not operate intermittently for within 20% of the total heater operation.

## 10-2 Communication Error

### 10-2-1 Communication Error

#### Indoor display

3-LED DISPLAY			7-SEG DISPLAY	DESCRIPTION
LED1	LED2	LED3	E101/E102	
◎	●	●		Communication error(Indoor<->outdoor)

#### Outdoor display

◎	●	●	1min. Time out Comm.
○	○	●	Abnormal Communication
○	●	●	

● LED ON      ◎ LED BLINKING      ○ LED OFF

#### 1. Checklist :

- 1) Is the cable between the indoor unit and outdoor unit connected correctly?
- 2) Isn't the power cable and communication cable cross?

#### 2. Troubleshooting procedure

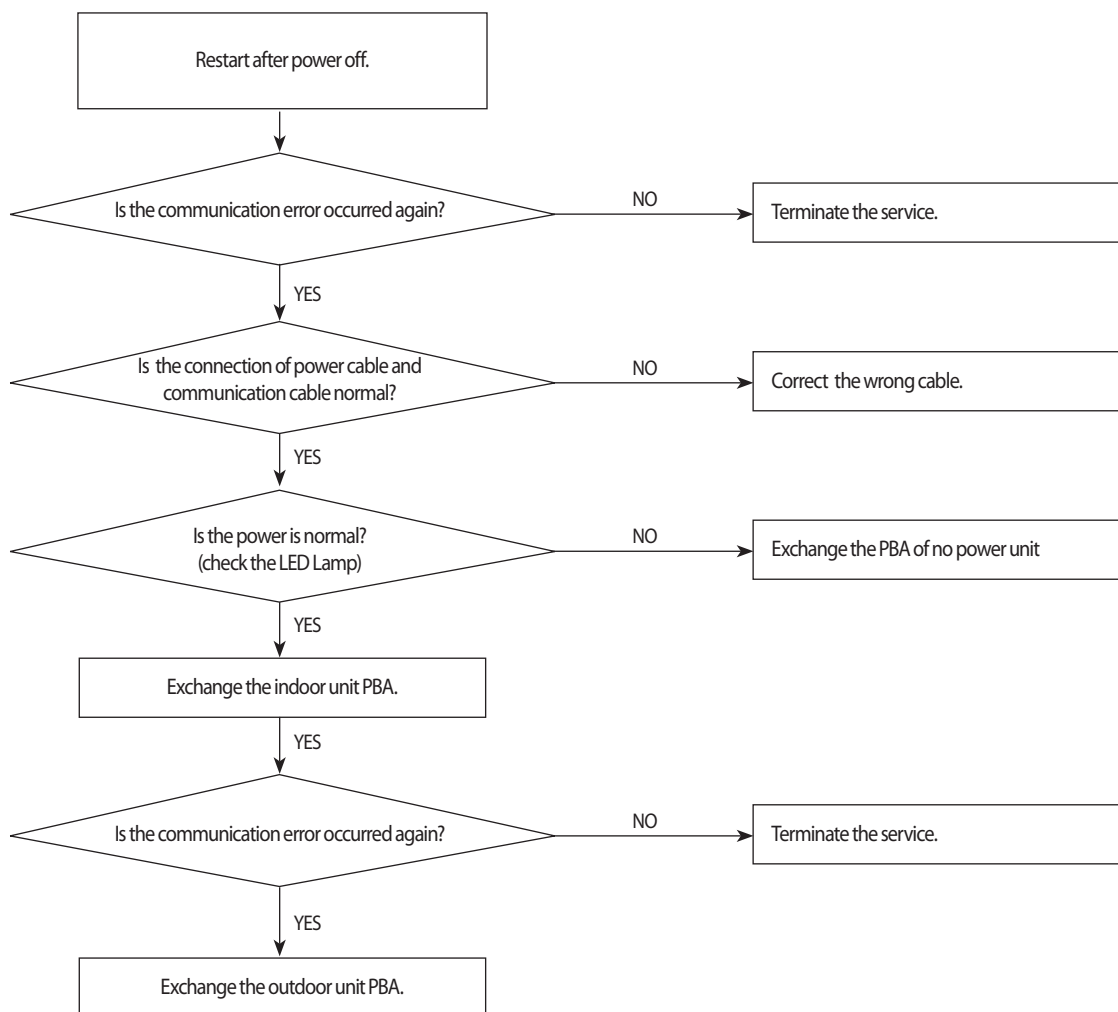

## 10-2-2 Indoor temperature sensor Error

### Indoor display

7-SEG DISPLAY	DESCRIPTION
E121	Indoor room temp sensor error

#### 1. Checklist :

- 1) Is the indoor units temperature sensor connected correctly?
- 2) Is the sensor placed correctly?
- 3) Does the both terminal of sensor satisfy the resistance value in accordance with temperature?

#### 2. Troubleshooting procedure

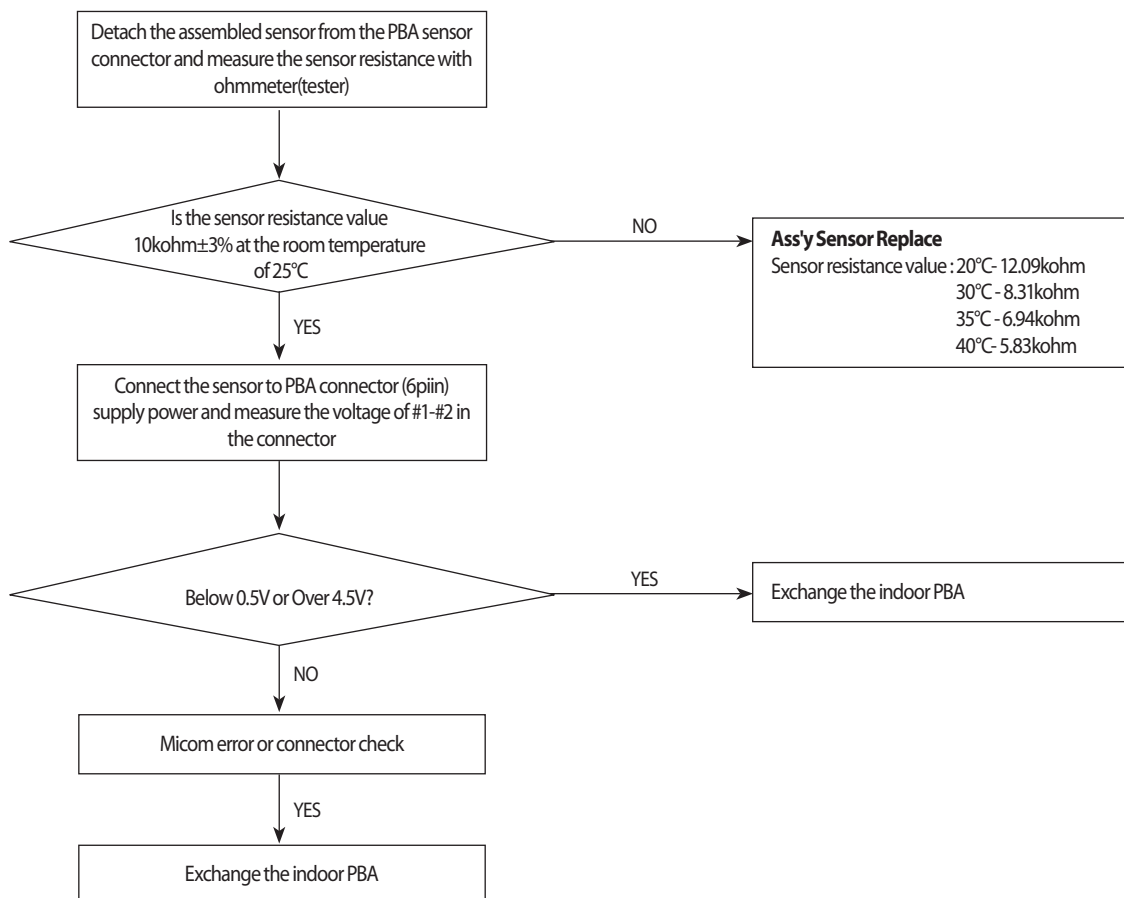

## 10-2-3 Indoor Eva-in temperature sensor error

### Indoor display

3-LED DISPLAY			7-SEG DISPLAY	DESCRIPTION
LED1	LED2	LED3	E122,E123	Indoor MID, Indoor IN PIPE-TH sensor error
⊙	⊙	○		

● LED ON      ⊙ LED BLINKING      ○ LED OFF

#### 1. Checklist :

- 1) Is the indoor units temperature sensor connected correctly?
- 2) Is the sensor placed correctly?
- 3) Does the both terminal of sensor satisfy the resistance value in accordance with temperature?

#### 2. Troubleshooting procedure

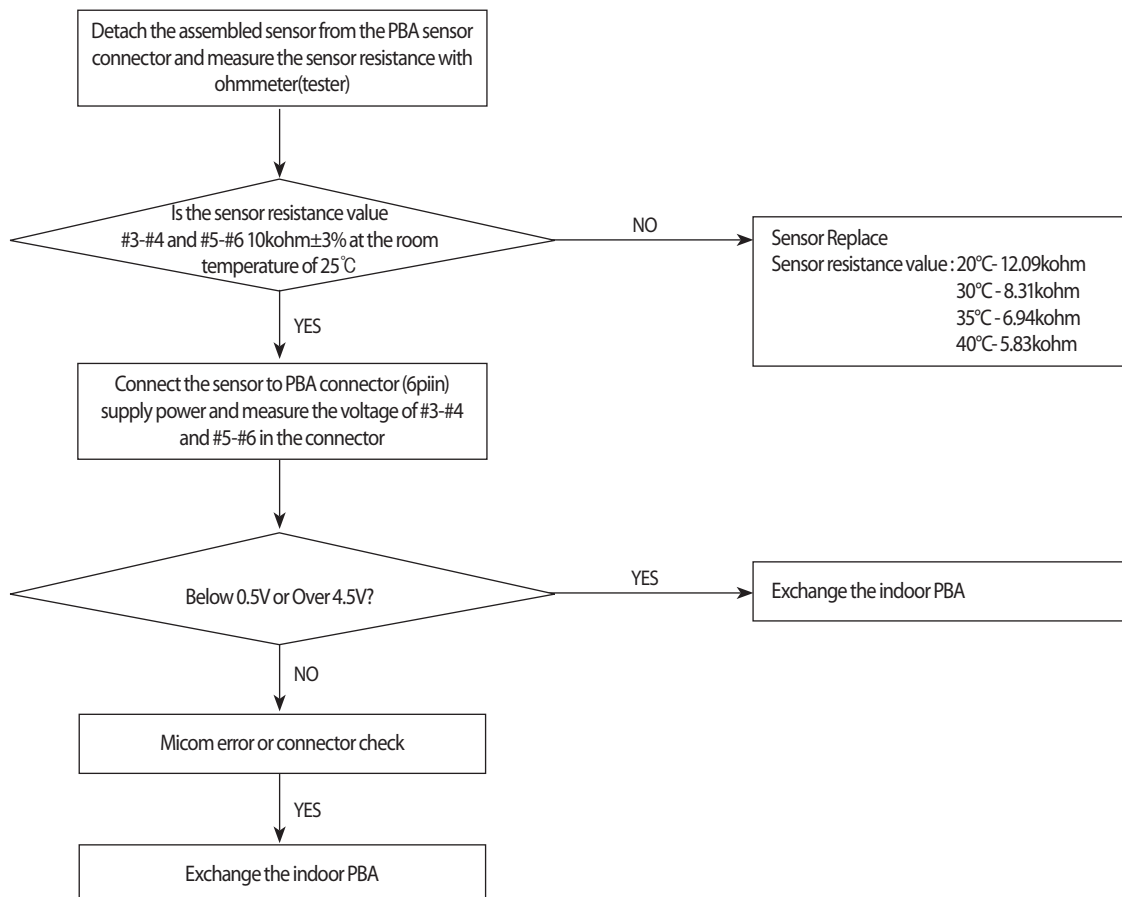



## 10-2-4 When the Up/Down, Left/Right, Grill louver motor does not operate (Initial Diagnosis) (Not displayed)

### 1. Checklist :

- 1) Is the input power voltage normal?
- 2) Is the Up/Down louver motor properly connected with the connector? (CN61, CN62, CN63)

### 2. Troubleshooting procedure

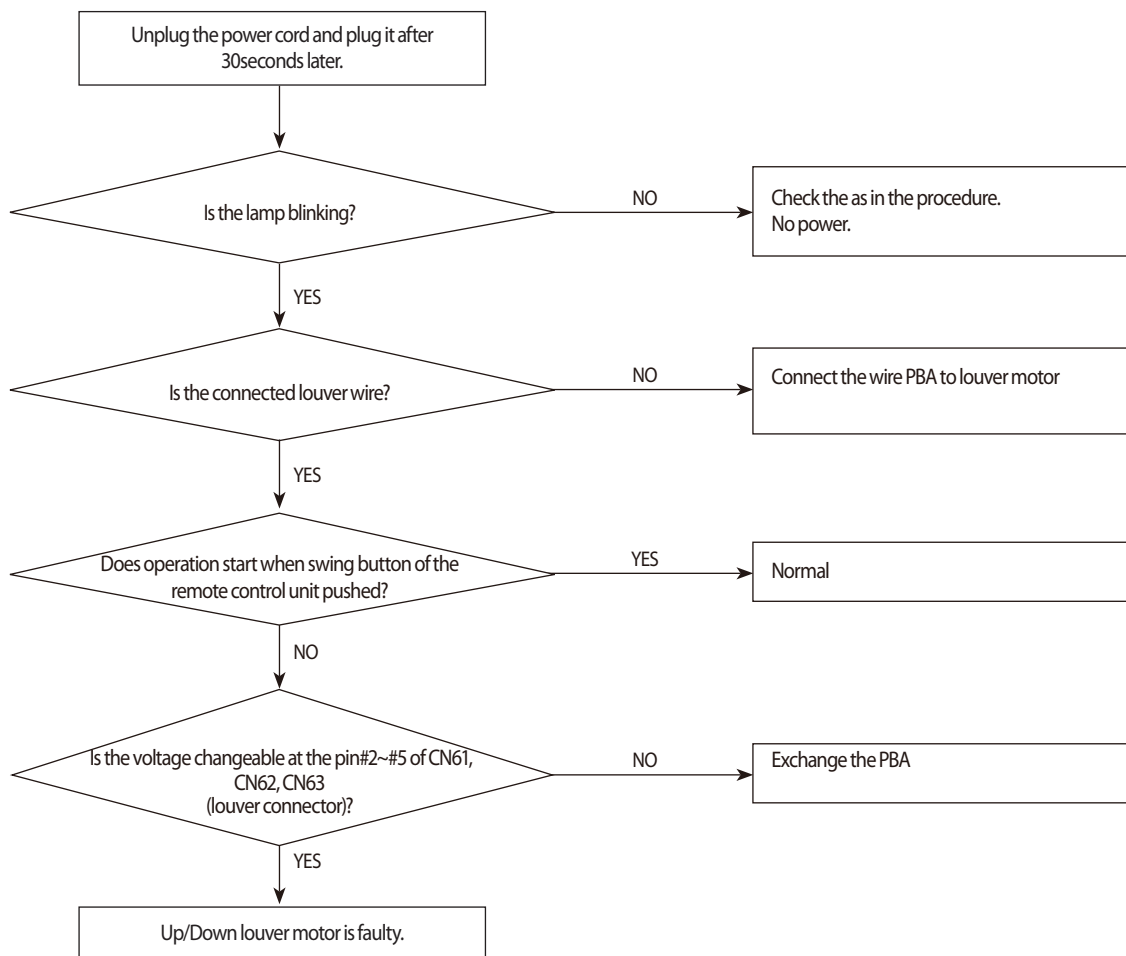

## 10-2-5 Indoor fan motor speed detecting error (BLDC fan)

### Indoor display

3-LED DISPLAY			7-SEG DISPLAY	DESCRIPTION
LED1	LED2	LED3	E154	Indoor fan error
○	○	◎		

● LED ON      ◎ LED BLINKING      ○ LED OFF

#### 1. Checklist :

- 1) Is the indoor units fan motor properly connected with the connector(CN72)?
- 2) Is the AC voltage correct?

#### 2. Troubleshooting procedure

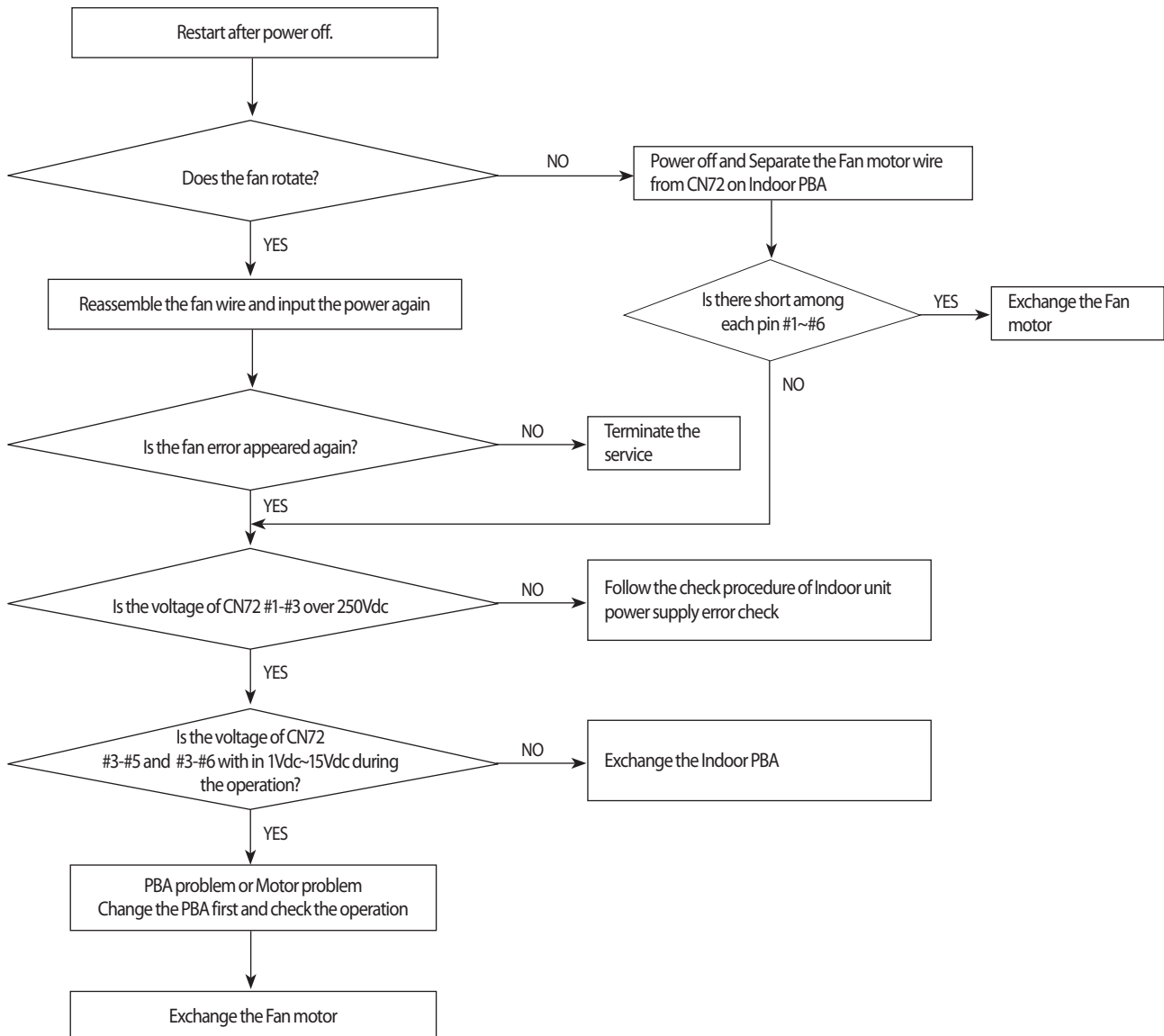

## 10-2-6 Outdoor temperature sensor error

### Indoor display

3-LED DISPLAY			7-SEG DISPLAY	DESCRIPTION
LED1	LED2	LED3	E221	Outdoor temperature sensor error
⊙	○	⊙		

### Outdoor display

⊙	○	⊙	Outdoor temperature sensor error
---	---	---	----------------------------------

● LED ON    ⊙ LED BLINKING    ○ LED OFF

#### 1. Checklist :

- 1) Is the sensor connected correctly?
- 2) Is the sensor placed correctly?
- 3) Does the both terminal of sensor satisfy the resistance value in accordance with temperature?
- 4) Is the resistance value of sensor connection pull-up correct?

#### 2. Troubleshooting procedure

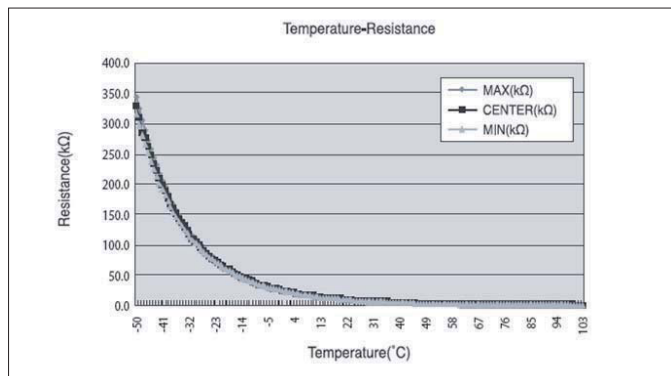
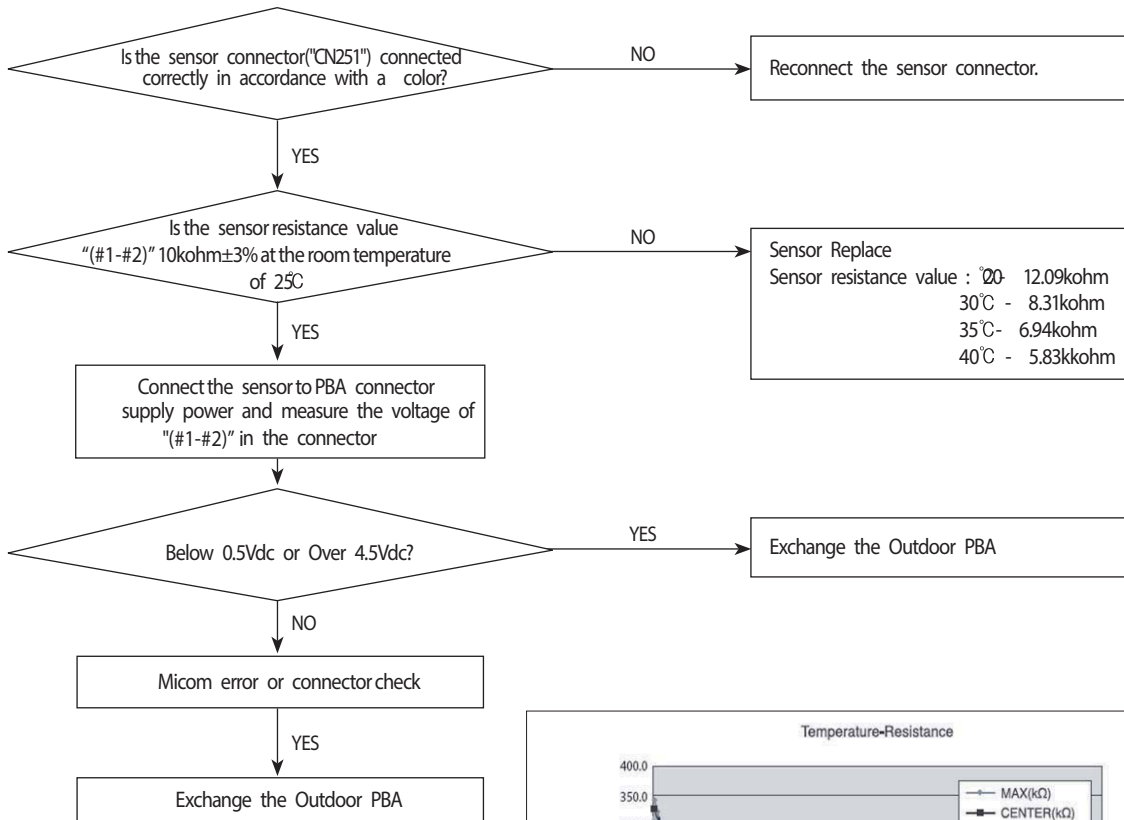

## 10-2-7 Outdoor Cond temperature sensor error

### Indoor display

3-LED DISPLAY			7-SEG DISPLAY	DESCRIPTION
LED1	LED2	LED3	E231	Outdoor Cond temperature sensor error
⊙	○	⊙		

### Outdoor display

⊙	●	⊙	Outdoor Cond temperature sensor error
---	---	---	---------------------------------------

● LED ON    ⊙ LED BLINKING    ○ LED OFF

#### 1. Checklist :

- 1) Is the sensor connected correctly?
- 2) Is the sensor placed correctly?
- 3) Does the both terminal of sensor satisfy the resistance value in accordance with temperature?
- 4) Is the resistance value of sensor connection pull-up correct?

#### 2. Troubleshooting procedure

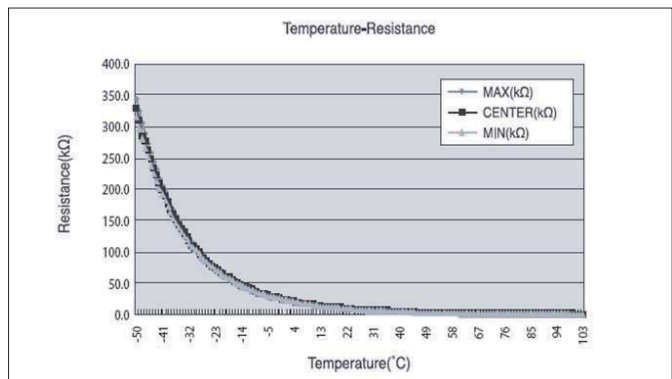
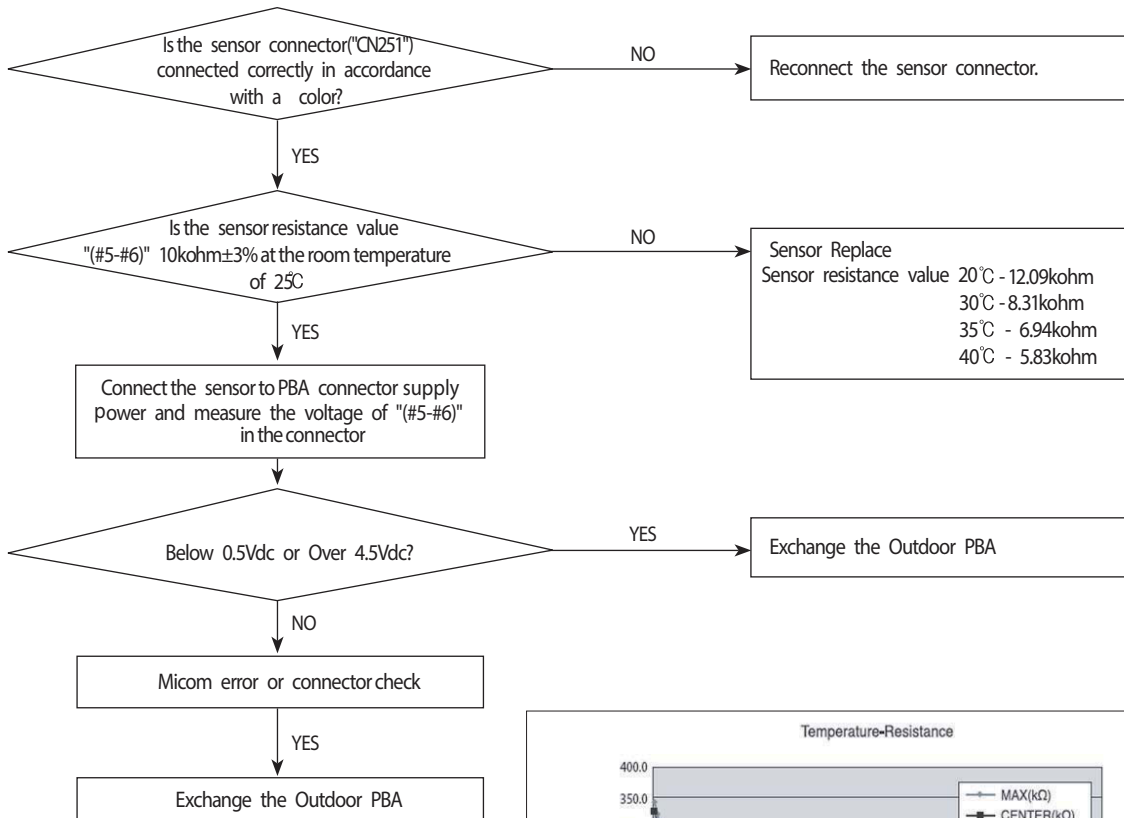

## 10-2-8 Outdoor Discharge temperature sensor error

### Indoor display

3-LED DISPLAY			7-SEG DISPLAY	DESCRIPTION
LED1	LED2	LED3	E251	Outdoor Discharge temperature sensor error
⊙	○	⊙		

### Outdoor display

⊙	⊙	○	Outdoor Discharge temperature sensor error
---	---	---	--

● LED ON    ⊙ LED BLINKING    ○ LED OFF

#### 1. Checklist :

- 1) Is the sensor connected correctly?
- 2) Is the sensor placed correctly?
- 3) Does the both terminal of sensor satisfy the resistance value in accordance with temperature?
- 4) Is the resistance value of sensor connection pull-up correct?

#### 2. Troubleshooting procedure

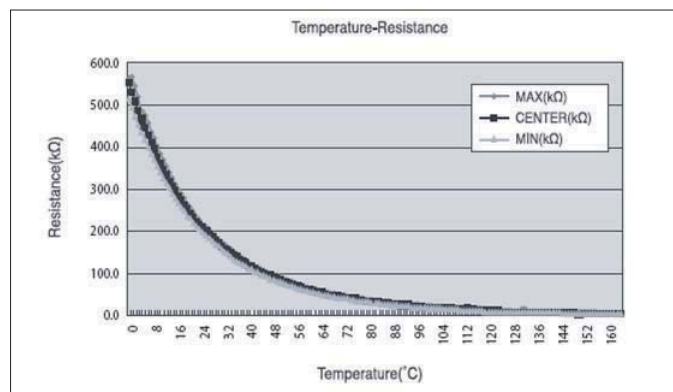
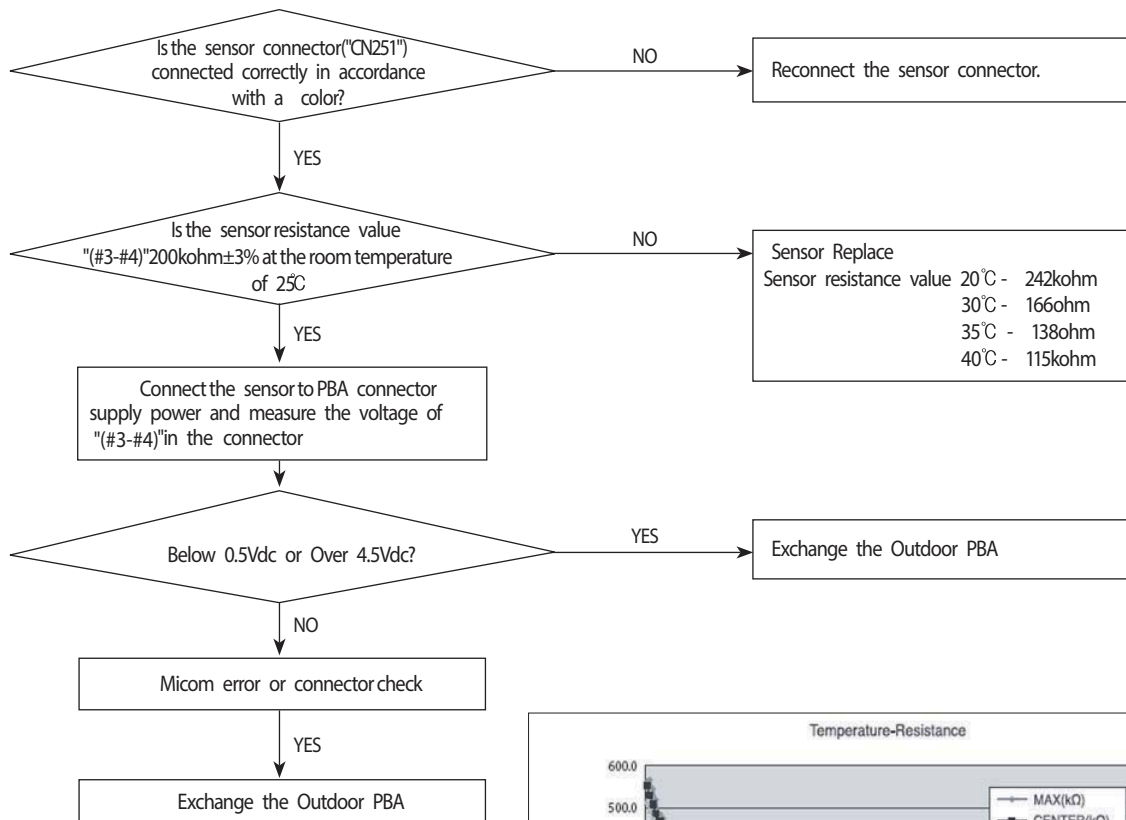

## 10-2-9 Outdoor Discharge over temperature error

### Indoor display

3-LED DISPLAY			7-SEG DISPLAY	DESCRIPTION
LED1	LED2	LED3	E416	Outdoor Discharge over temperature error
⊙	○	⊙		

### Outdoor display

⊙	⊙	●	Outdoor Discharge over temperature error
---	---	---	--

● LED ON    ⊙ LED BLINKING    ○ LED OFF

#### 1. Checklist :

- 1) Check the discharge temperature in the outdoor unit
- 2) Check the compressor locking or gas leak
- 3) Download the EEPROM data

#### 2. Troubleshooting procedure

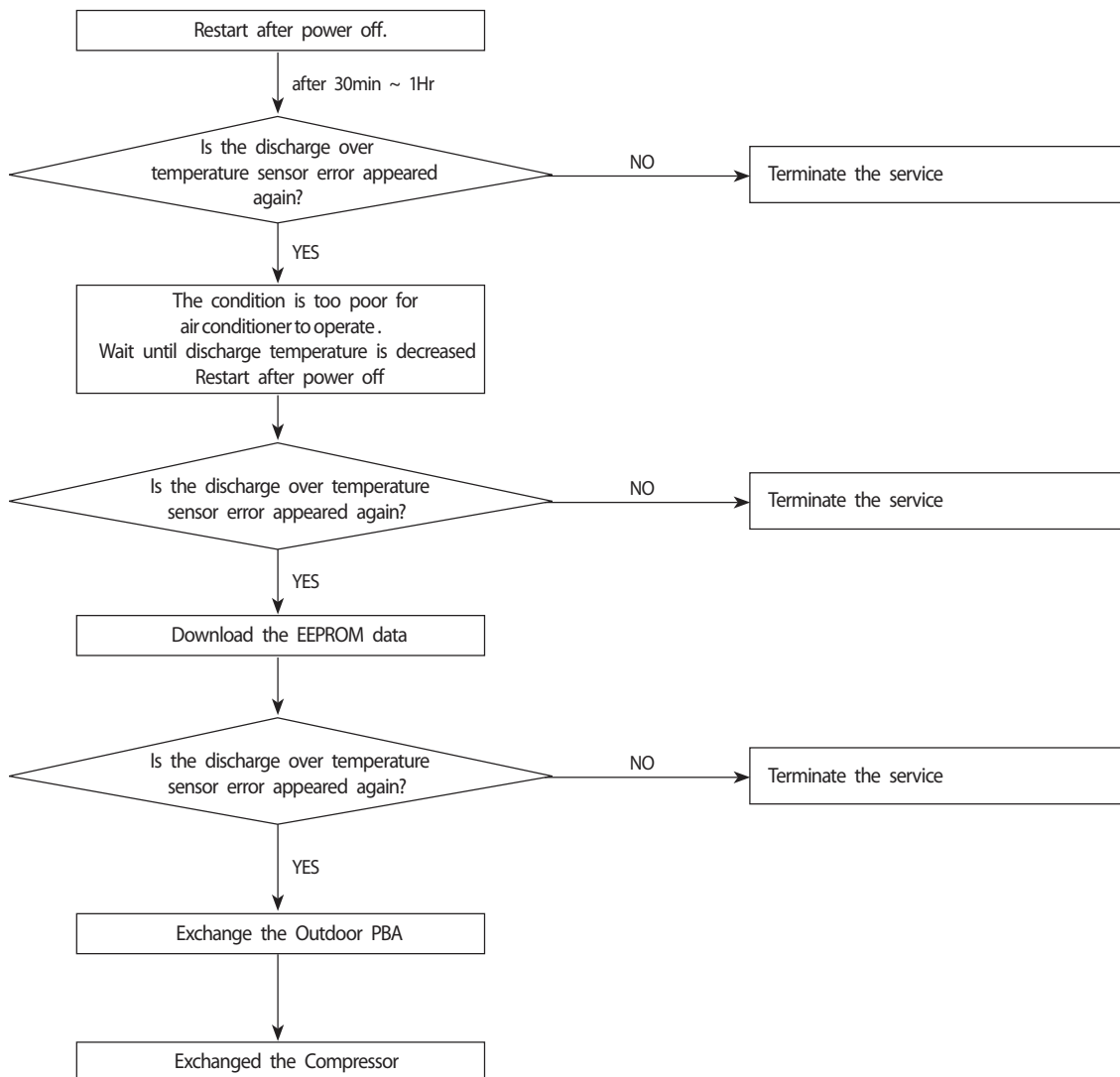

## 10-2-10 Outdoor Fan motor error

### Indoor display

3-LED DISPLAY			7-SEG DISPLAY	DESCRIPTION
LED1	LED2	LED3	E458	Outdoor fan error
◎	○	◎		

### Outdoor display

●	○	○	Outdoor fan error
---	---	---	-------------------

● LED ON    ◎ LED BLINKING    ○ LED OFF

#### 1. Checklist :

- 1) Are the input power voltage and the power connection correct?
- 2) Is the motor wire connected to the outdoor PBA correctly?
- 3) Is there no assembly error or non-assembly in the terminal of motor wire connector?
- 4) Is there no obstacle at the surrounding of motor and propeller?

#### 2. Troubleshooting procedure

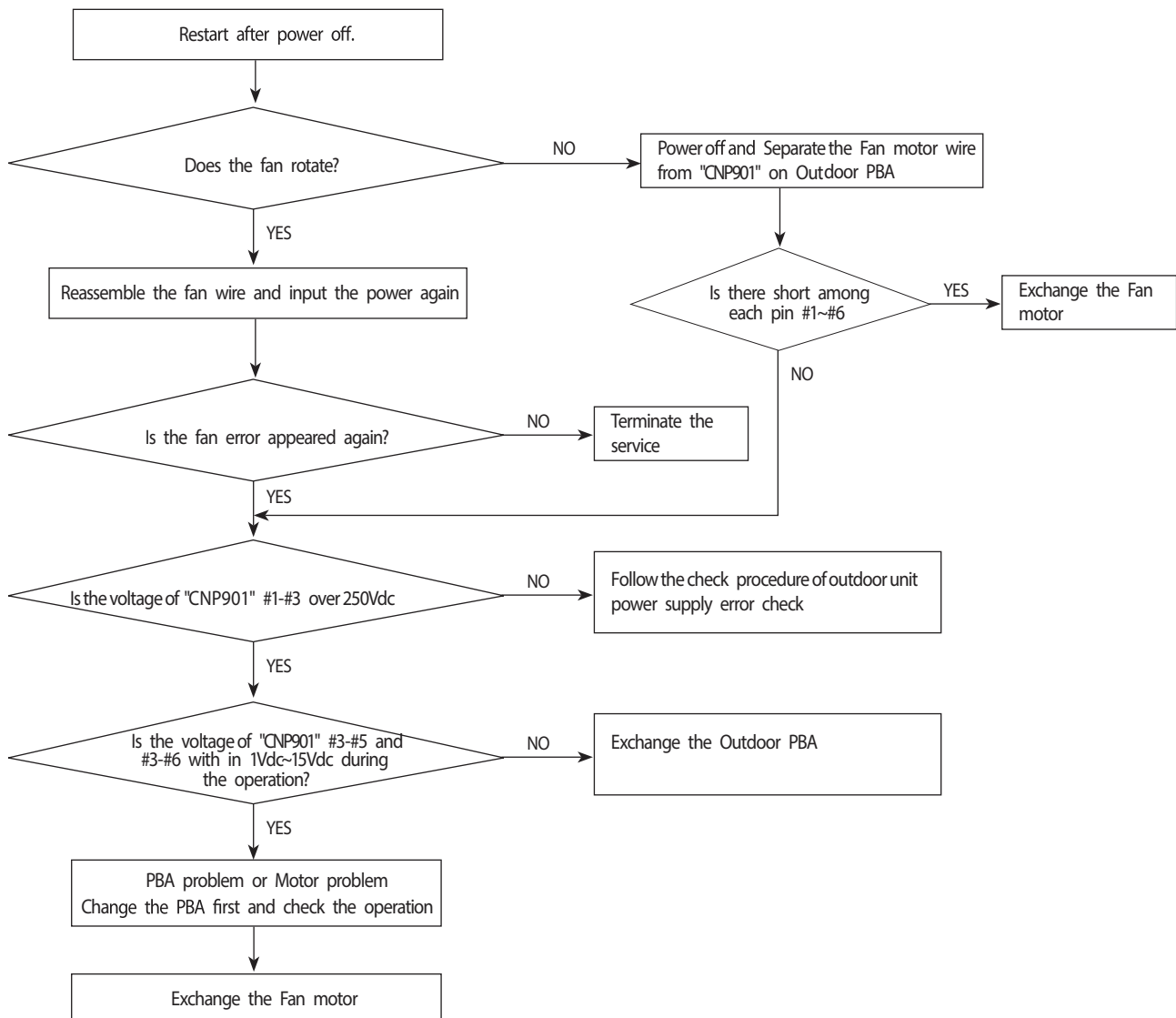

## 10-2-11 Compressor starting error

### Indoor display

3-LED DISPLAY			7-SEG DISPLAY	DESCRIPTION
LED1	LED2	LED3	E461	Comp starting error
⊙	○	⊙		

### Outdoor display

○	⊙	○	Comp starting error
---	---	---	---------------------

● LED ON    ⊙ LED BLINKING    ○ LED OFF

#### 1. Checklist :

- 1) Is the connection of cable for the compressor?
- 2) Is the compressor wire is connected clockwise? U(RED)-V(BLU)-W(YEL)
- 3) Is the interphase resistance of compressor normal?

#### 2. Troubleshooting procedure

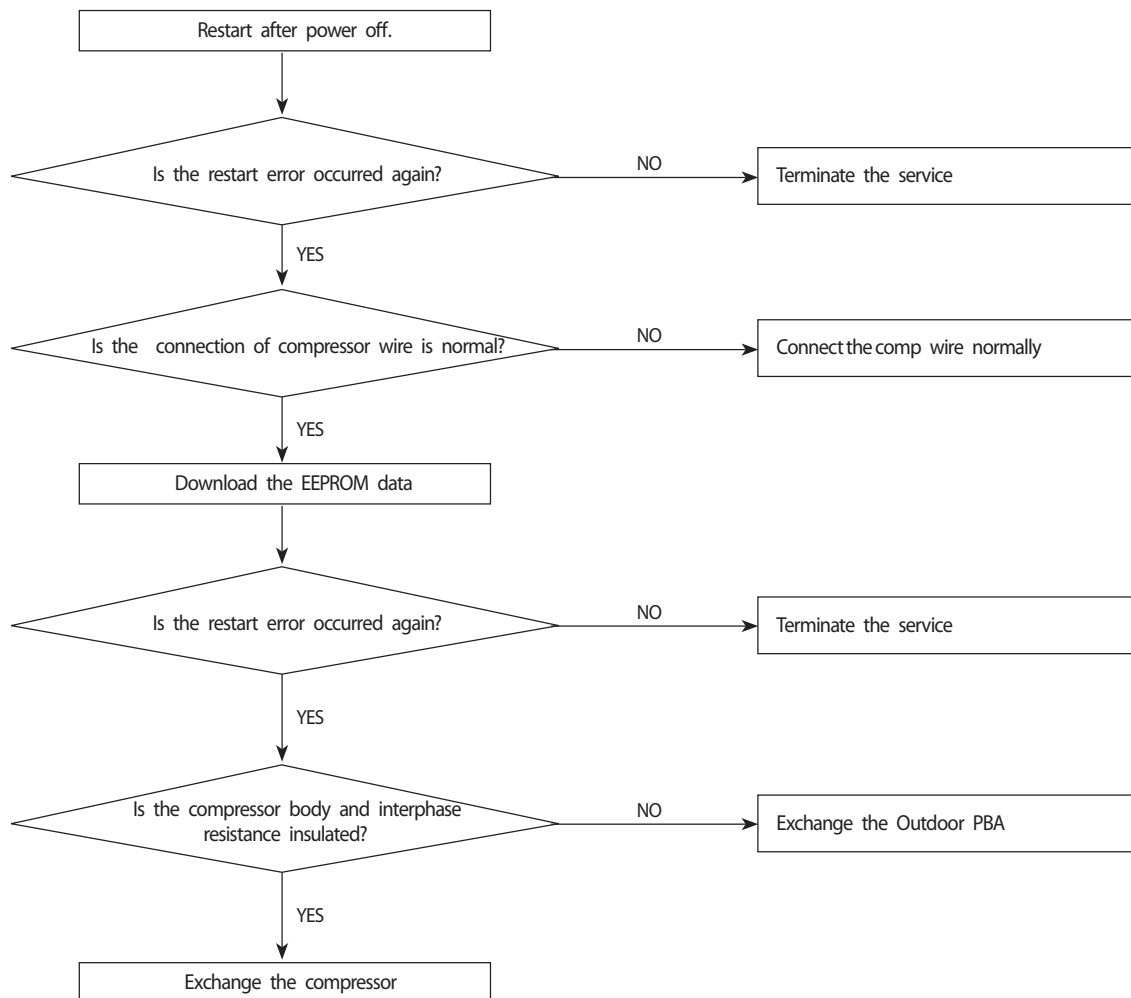



## 10-2-12 Compressor wire missing error/rotation error

### Indoor display

3-LED DISPLAY			7-SEG DISPLAY	DESCRIPTION
LED1	LED2	LED3	E467	Compressor wire missing error/rotation error
◎	○	◎		

### Outdoor display

●	○	●	Compressor wire missing error/rotation error
---	---	---	--

● LED ON    ◎ LED BLINKING    ○ LED OFF

#### 1. Checklist :

- 1) Is the connection of cable for the compressor?
- 2) Is the compressor wire is connected clockwise? U(RED)-V(BLU)-W(YEL)
- 3) Is the interphase resistance of compressor normal?

#### 2. Troubleshooting procedure

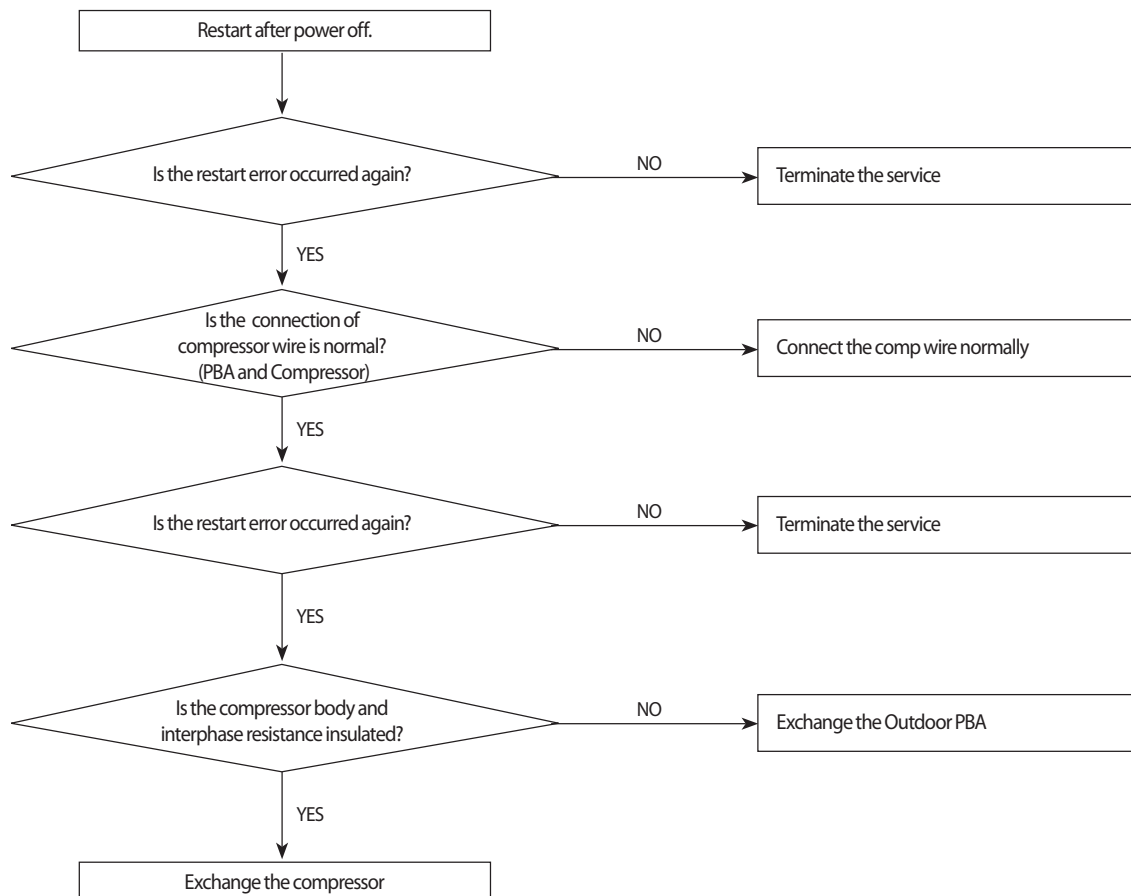

### 10-2-13 O.C(Over Current) error

#### Indoor display

3-LED DISPLAY			7-SEG DISPLAY	DESCRIPTION
LED1	LED2	LED3	E464	IPM Over Current(O.C) Error
⊙	○	⊙		

#### Outdoor display

○	○	⊙	IPM Over Current(O.C) Error
---	---	---	-----------------------------

● LED ON    ⊙ LED BLINKING    ○ LED OFF

#### 1. Checklist :

- 1) Is the IPM Shunt resistance value correct? Check the resistor is opened
- 2) Is the condition of surrounding temperature abnormal overload?
- 3) Is there any problem as like the temperature sensor separation or measurement value error?
- 4) Is the interphase resistance of compressor normal?

#### 2. Troubleshooting procedure

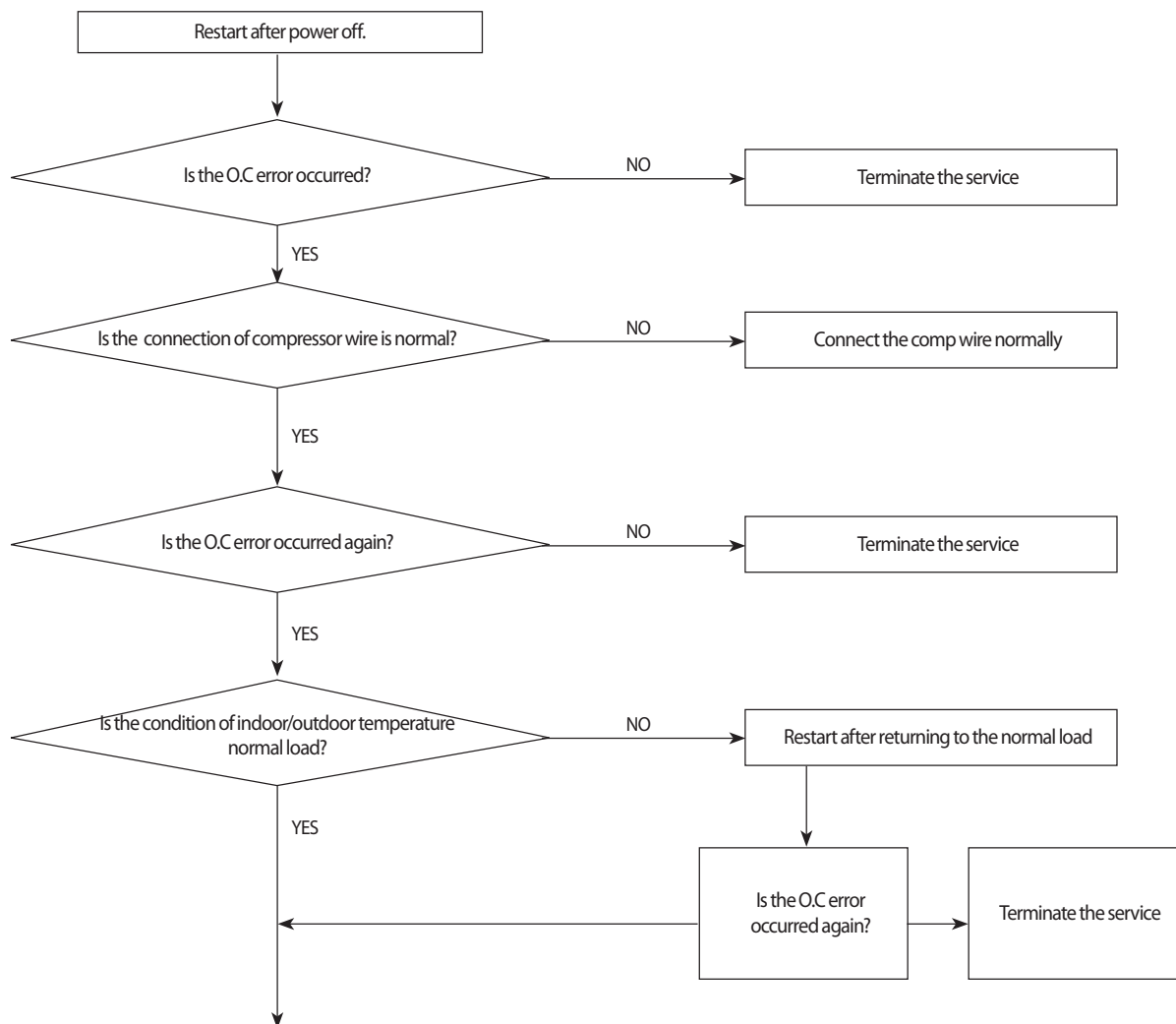

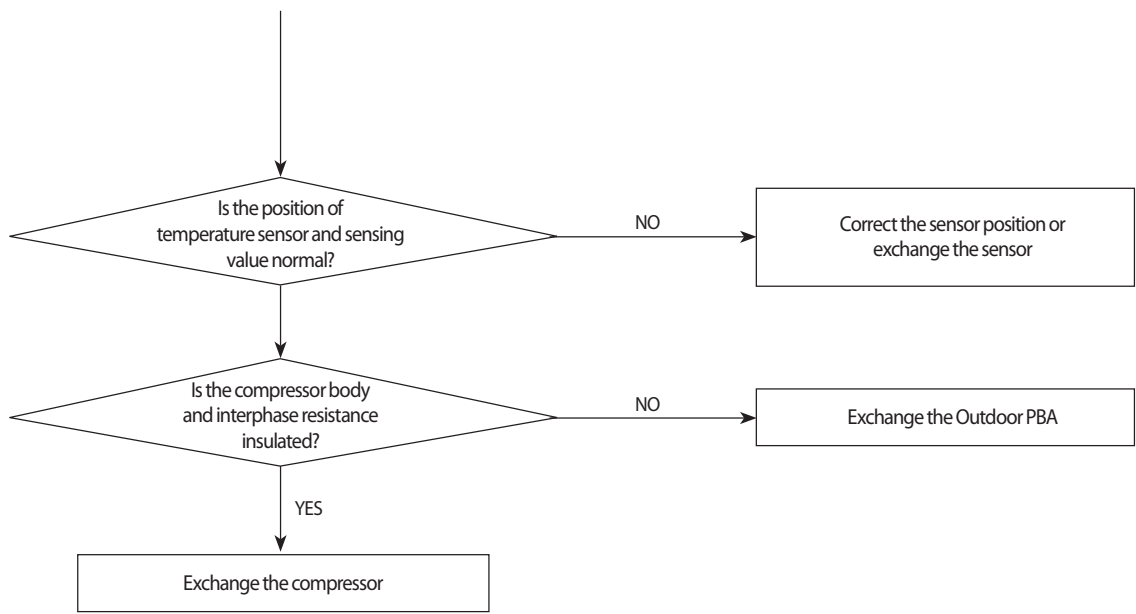

## 10-2-14 DC\_link voltage sensor error

### Indoor display

3-LED DISPLAY			7-SEG DISPLAY	DESCRIPTION
LED1	LED2	LED3	E469	DC_link voltage sensor error
⊙	○	⊙		

### Outdoor display

●	⊙	⊙	DC_link voltage sensor error
---	---	---	------------------------------

● LED ON    ⊙ LED BLINKING    ○ LED OFF

#### 1. Checklist :

- 1) Is the input voltage of outdoor terminal block is normal?
- 2) Is the reactor wire connected?

#### 2. Troubleshooting procedure

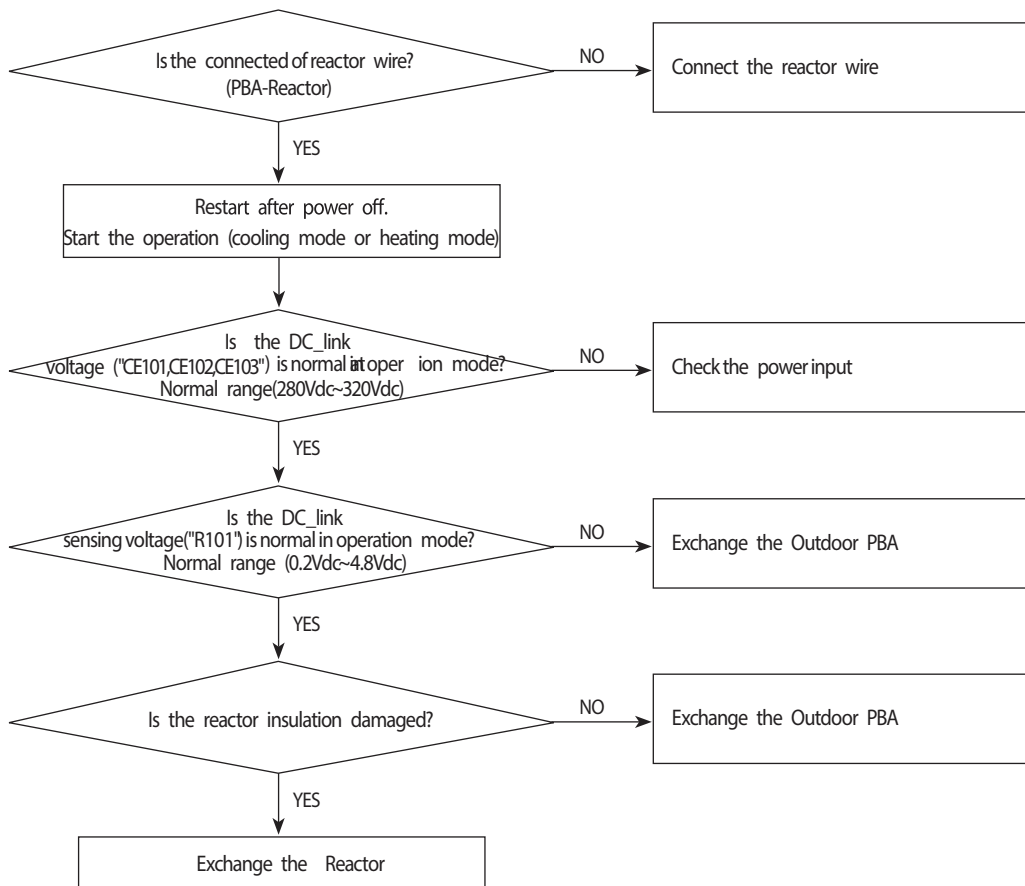

## 10-2-15 DC\_link voltage sensor error

### Indoor display

3-LED DISPLAY			7-SEG DISPLAY	DESCRIPTION
LED1	LED2	LED3	E488	AC Input Voltage Sensor Error
⊙	○	⊙		

### Outdoor display

●	⊙	⊙	AC Input Voltage Sensor Error
---	---	---	-------------------------------

● LED ON    ⊙ LED BLINKING    ○ LED OFF

#### 1. Checklist :

- 1) Is the input voltage of outdoor terminal block is normal?
- 2) Is the reactor wire connected?
- 3) Is the PFC resistor("A") value is normal? (Outdoor PBA)

#### 2. Troubleshooting procedure

MODEL	"A"	"B"
DB92-02866A/2867A	R105,R106,R107,R108	R105

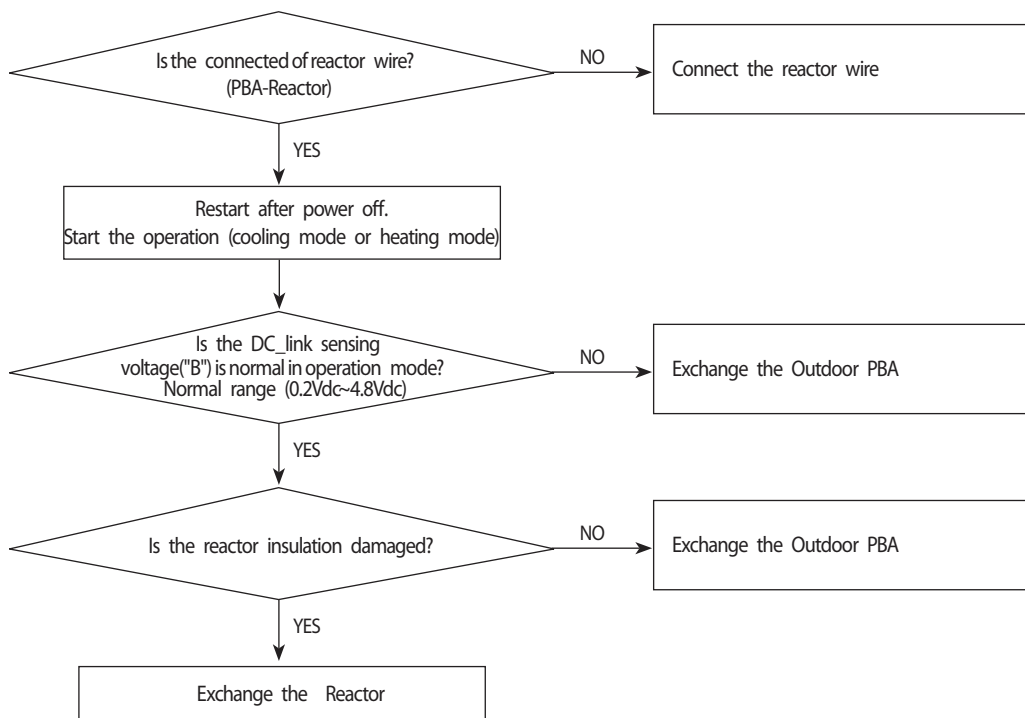

## 10-2-16 DC\_link voltage under/over error, H/W DC-link Over voltage protection error/PFC over load

### Indoor display

3-LED DISPLAY			7-SEG DISPLAY	DESCRIPTION
LED1	LED2	LED3	E466	DC-Link voltage under/over error
⊙	○	⊙	E483	Over Voltage Protection Error
			E484	PFC over load

### Outdoor display

○	●	⊙	DC-Link voltage under/over error
			PFC over load
			Over Voltage Protection Error

● LED ON    ⊙ LED BLINKING    ○ LED OFF

#### 1. Checklist :

- 1) Is the input voltage of outdoor terminal block is normal?
- 2) Is the input voltage is higher than 300Vac?
- 3) Is the reactor wire connected?

#### 2. Troubleshooting procedure

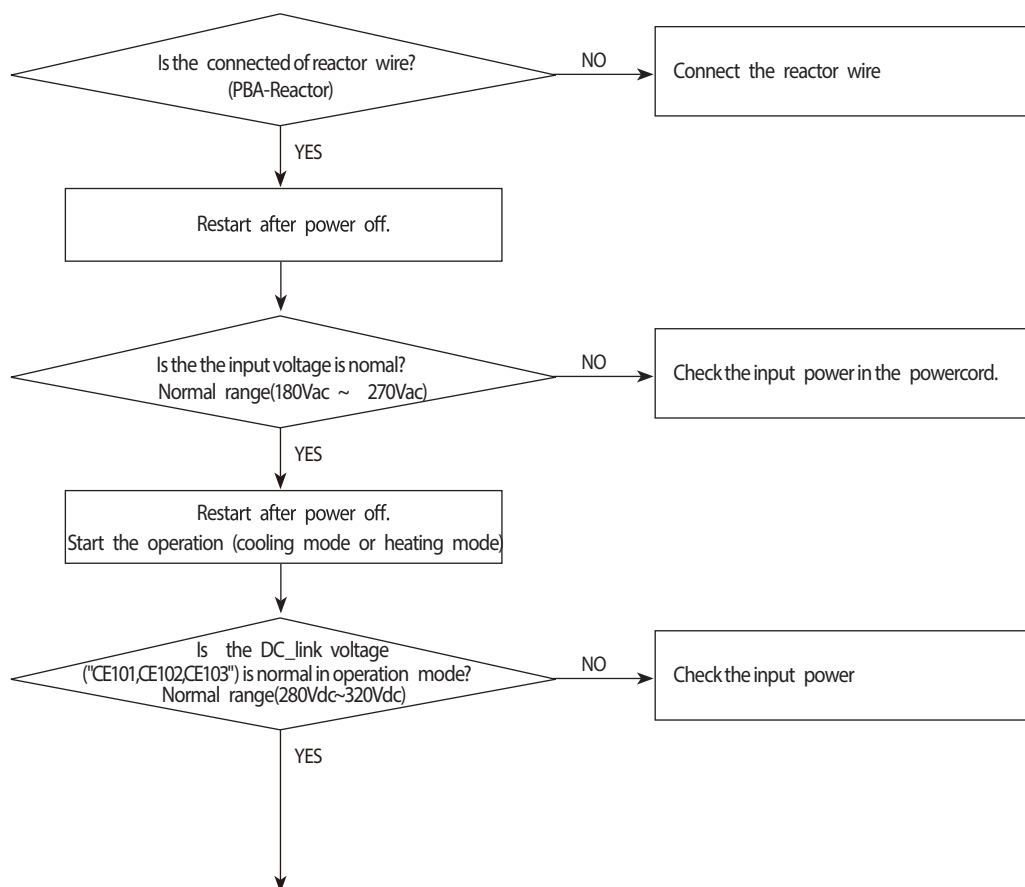

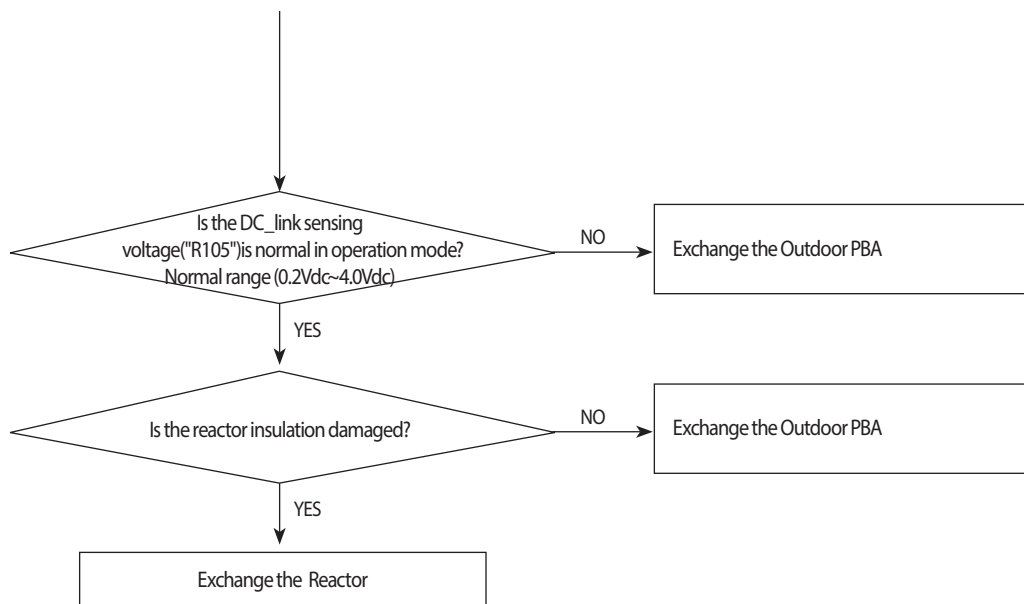



## 10-2-17 I\_trip error, PFC over current

### Indoor display

3-LED DISPLAY			7-SEG DISPLAY	DESCRIPTION
LED1	LED2	LED3	E462	AC Input I_Limit Trip Error
⊙	○	⊙		

### Outdoor display

●	⊙	●	AC Input I_Limit Trip Error
---	---	---	-----------------------------

● LED ON    ⊙ LED BLINKING    ○ LED OFF

#### 1. Checklist :

- 1) Is the PFC Shunt("R410,R411") resistance value correct? Check the resistor is opened
- 2) Is the condition of surrounding temperature abnormal overload?
- 3) Is there any problem as like the temperature sensor separation or measurement value error?
- 4) Is the interphase resistance of compressor normal?

#### 2. Troubleshooting procedure

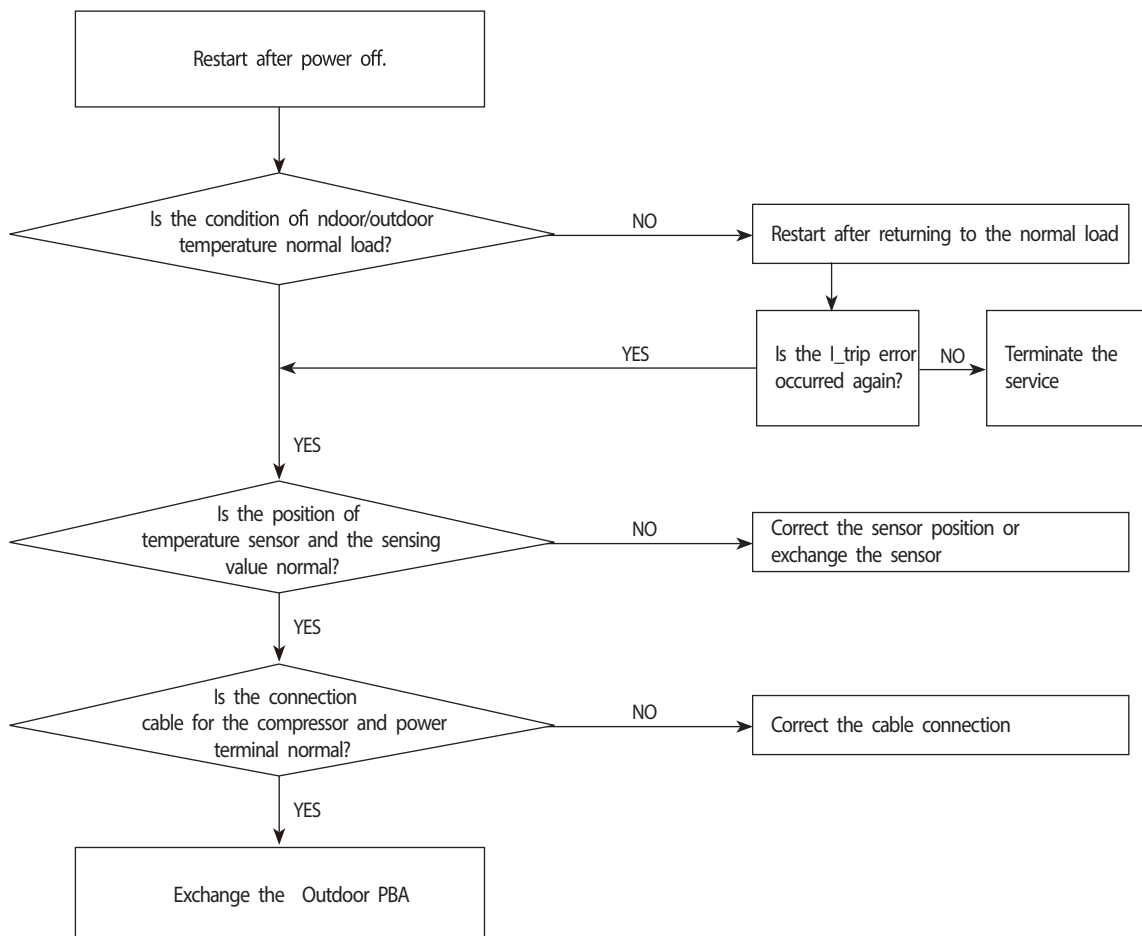

## 10-2-18 Current sensor error/Input current sensor error

### Indoor display

3-LED DISPLAY			7-SEG DISPLAY	DESCRIPTION
LED1	LED2	LED3		
⊙	○	⊙	E462	AC Input I_Limit Trip Error

### Outdoor display

⊙	⊙	●	Current sensor error
			Input current sensor error

● LED ON    ⊙ LED BLINKING    ○ LED OFF

#### 1. Checklist :

- 1) Is the PFC Shunt("R701,R702") resistance value correct? Check the resistor is opened
- 2) Is the IPM Shunt("R410,R411") resistance value correct? Check the resistor is opened
- 3) Is there no short or open around "IC451"?

#### 2. Troubleshooting procedure

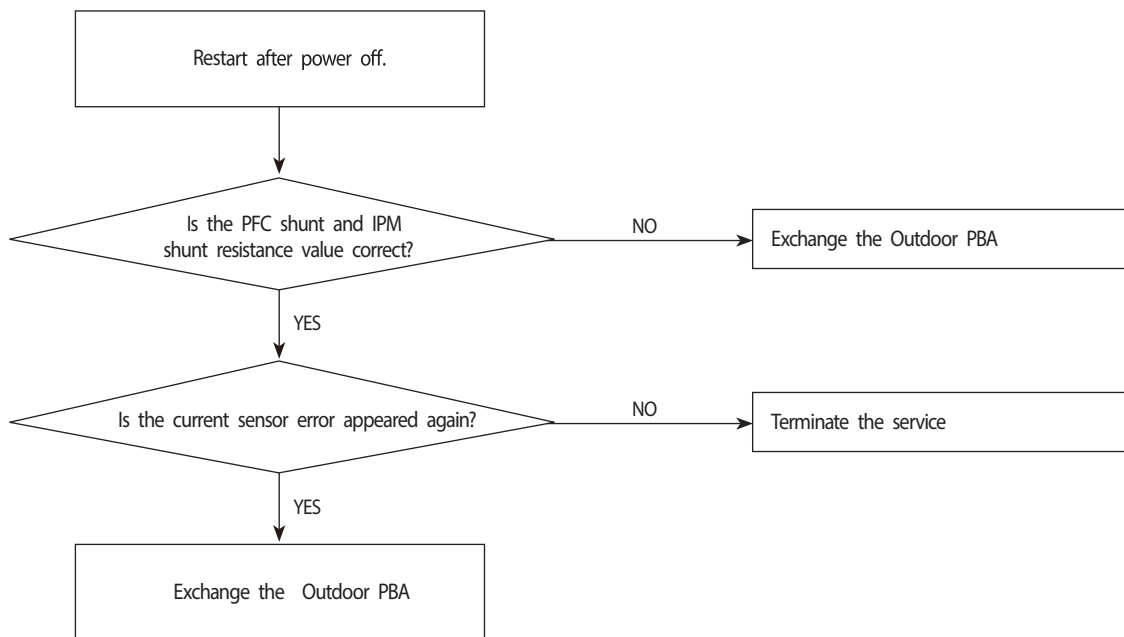

## 10-2-19 Heatsink sensor error/Heatsink over heat

### Indoor display

3-LED DISPLAY			7-SEG DISPLAY	DESCRIPTION
LED1	LED2	LED3		
⊙	○	⊙	E474	Heatsink sensor error
			E500	Heatsink Over Temperature Error

### Outdoor display

⊙	⊙	●	Heatsink sensor error
⊙	●	○	Heatsink Over Temperature Error

● LED ON    ⊙ LED BLINKING    ○ LED OFF

#### 1. Checklist :

- 1) Are there screws assembly in PBA-heatsink?
- 2) Is the gap PBA-heatsink
- 3) Is the fan operation normal?
- 4) Is the cover assembly in control-box normal?

#### 2. Troubleshooting procedure

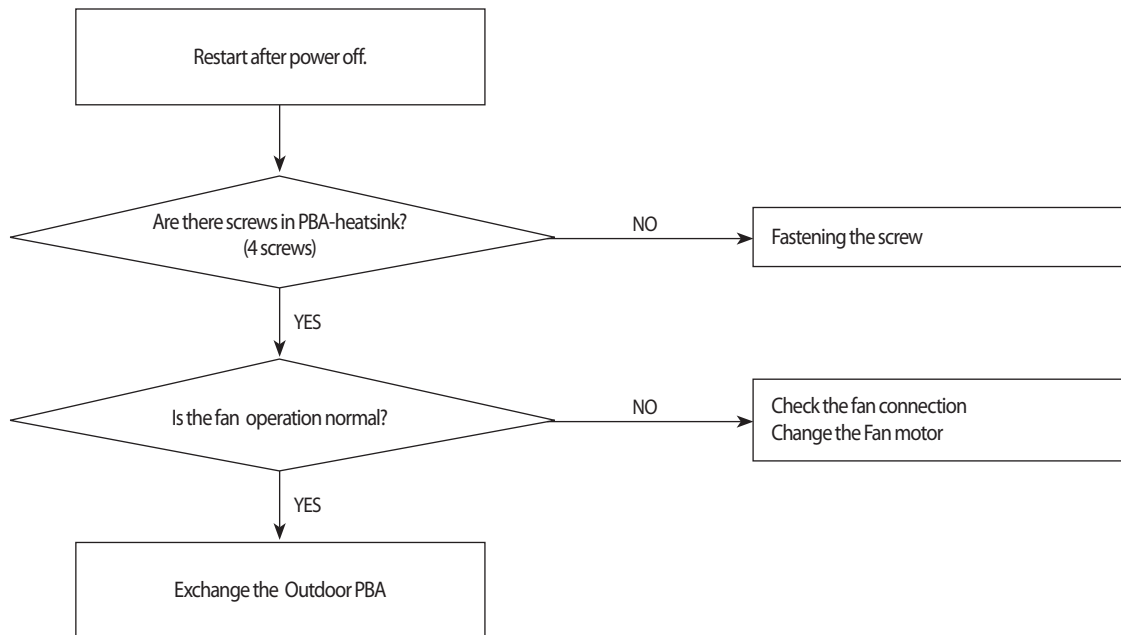

## 10-2-20 Comp Vlimit error

### Indoor display

3-LED DISPLAY			7-SEG DISPLAY	DESCRIPTION
LED1	LED2	LED3		
⊙	○	⊙	E465	Comp V_limit/I_limit Error

### Outdoor display

⊙	●	○	Comp V_limit/I_limit Error	
---	---	---	----------------------------	--

● LED ON    ⊙ LED BLINKING    ○ LED OFF

#### 1. Checklist :

- 1) Is the IPM Shunt("R701,R702") resistance value correct? Check the resistor is opened
- 2) Is the condition of surrounding temperature abnormal overload?
- 3) Is there any problem as like the temperature sensor separation or measurement value error?
- 4) Is the interphase resistance of compressor normal?

#### 2. Troubleshooting procedure

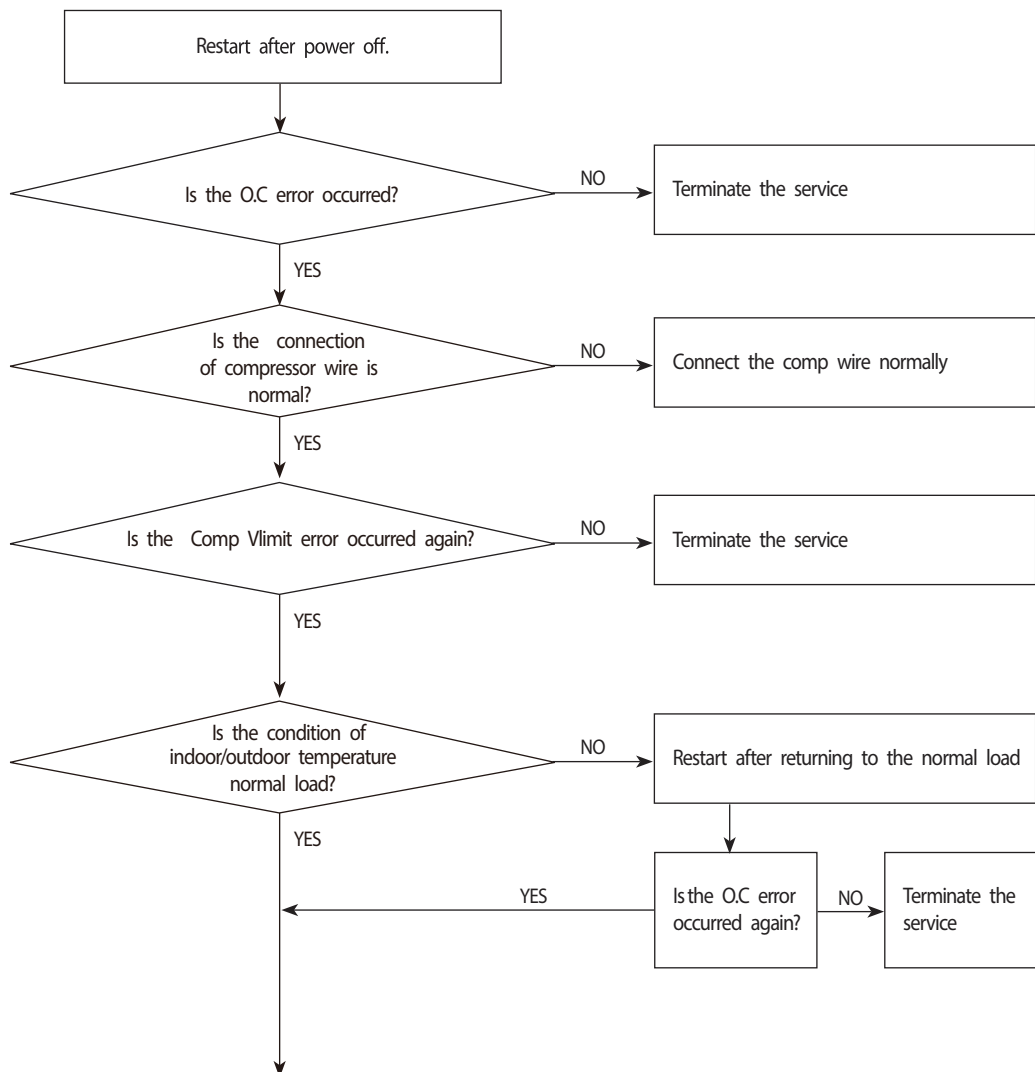

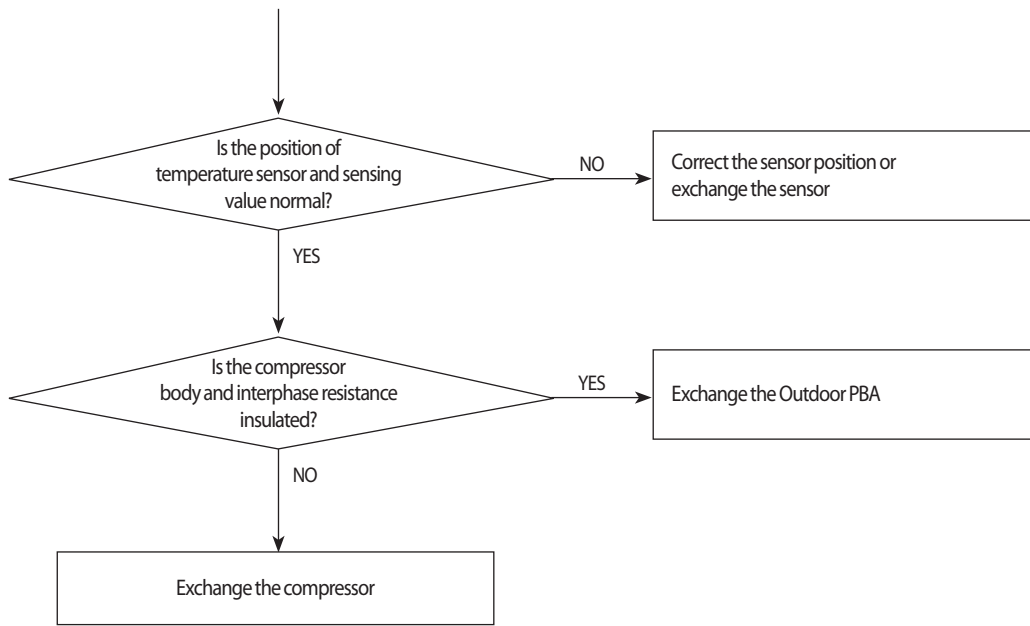

## 10-2-21 EEPROM error/OTP error

### Indoor display

3-LED DISPLAY			7-SEG DISPLAY	DESCRIPTION
LED1	LED2	LED3		
◎	○	◎	E470	EEPROM Data Error (no data)
			E471	OTP errorEEPROM Data Error (Main Micom→Inv Micom)

### Outdoor display

○	●	○	EEPROM Data Error (no data)
●	○	◎	OTP errorEEPROM Data Error (Main Micom Inv Micom)

● LED ON    ◎ LED BLINKING    ○ LED OFF

#### 1. Checklist :

- 1) Is there a short around micom?
- 2) Is there a short around "A"?
- 3) Did you download or insert EEPROM IC, after changing outdoor PBA?

#### 2. Troubleshooting procedure

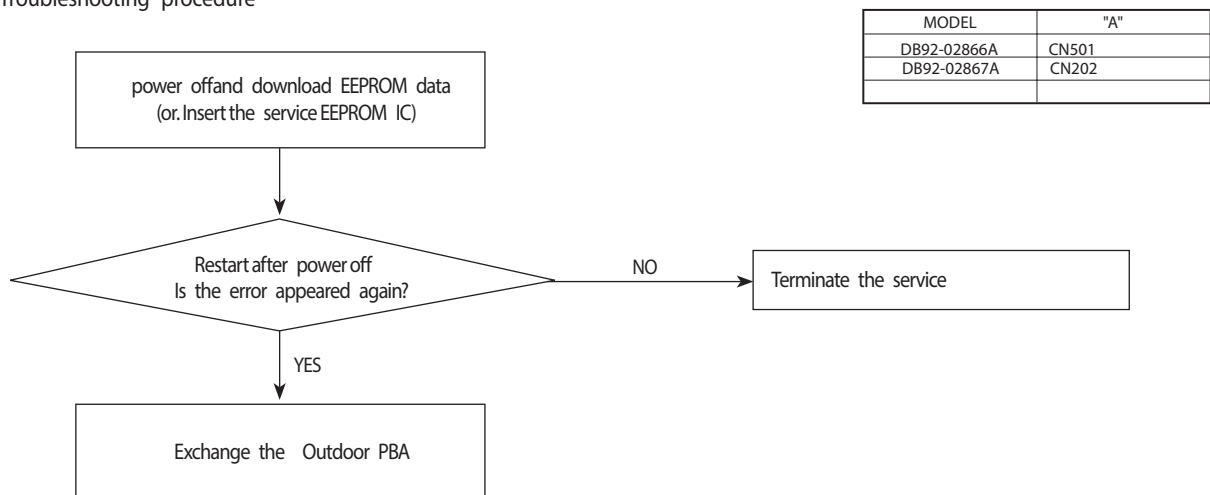

## 10-2-22 Operation condition secession error

### Indoor display

3-LED DISPLAY			7-SEG DISPLAY	DESCRIPTION
LED1	LED2	LED3		
◎	○	◎	E440	Prohibit Operation Condition Error (Heating)
			E441	Prohibit Operation Condition Error (Cooling)

### Outdoor display

●	◎	○	Operation condition secession
---	---	---	-------------------------------

● LED ON    ◎ LED BLINKING    ○ LED OFF

#### 1. Checklist :

- 1) Check the temperature around the outdoor unit.

#### 2. Troubleshooting procedure

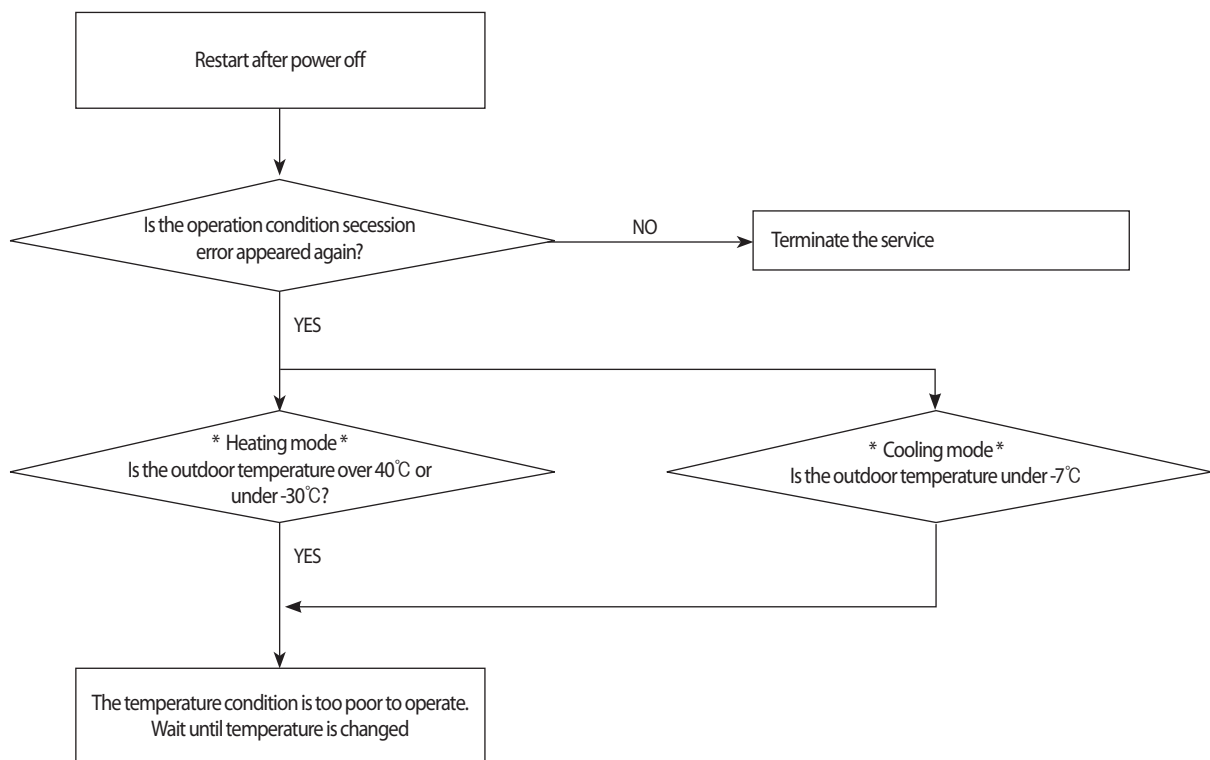

## 10-2-23 Gas leak error

### Indoor display

3-LED DISPLAY			7-SEG DISPLAY	DESCRIPTION
LED1	LED2	LED3		
◎	○	◎	E554	GAS Leak error

### Outdoor display

●	●	○	GAS Leak error	
---	---	---	----------------	--

● LED ON    ◎ LED BLINKING    ○ LED OFF

#### 1. Checklist :

- 1) Is the position of indoor Eva\_in sensor normal?
- 2) Check the pipe crack
- 3) Check the EEV valve connection("CN701 ") in Outdoor unit
- 4) Check the refrigerant was charged

#### 2. Troubleshooting procedure

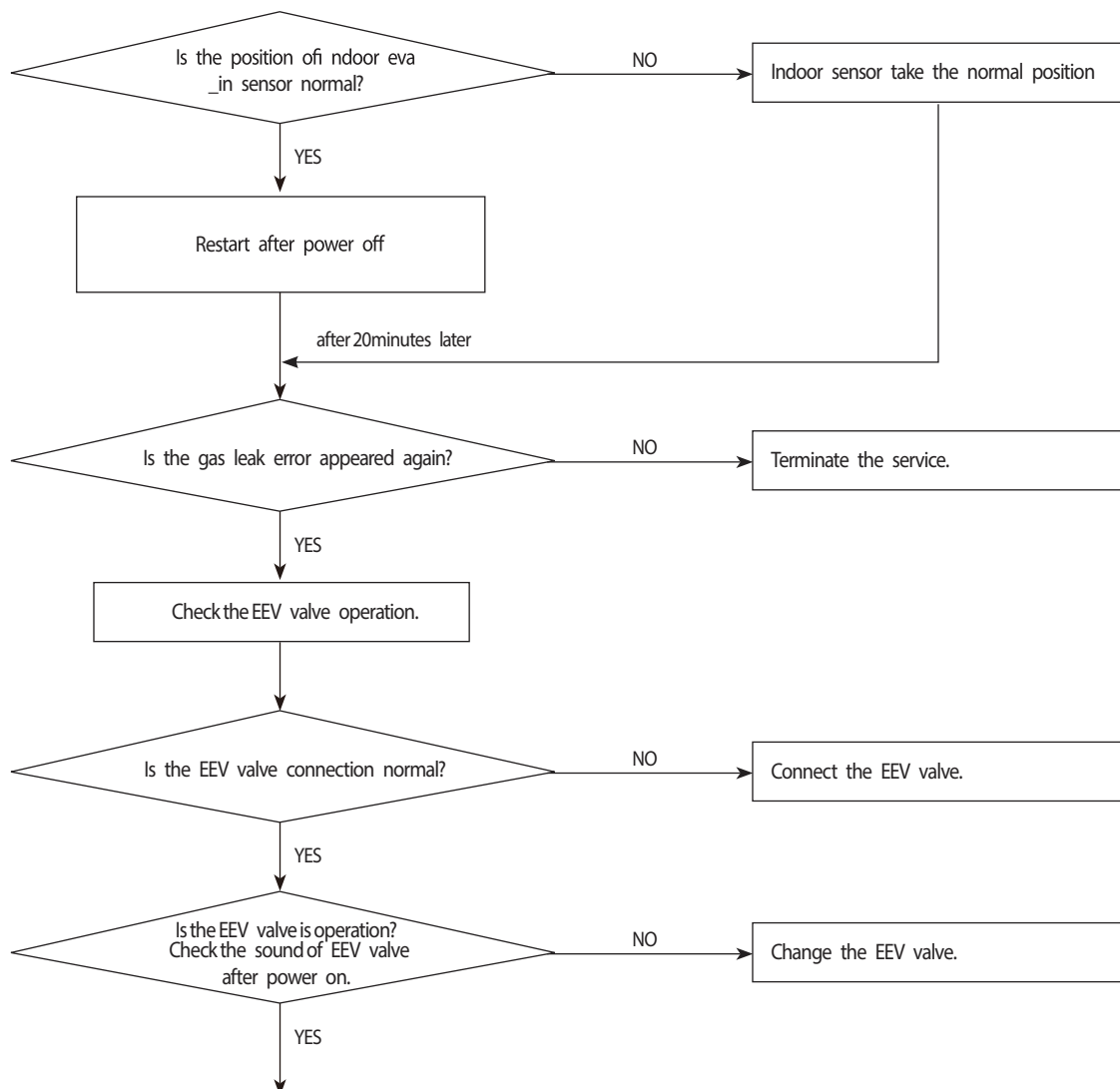



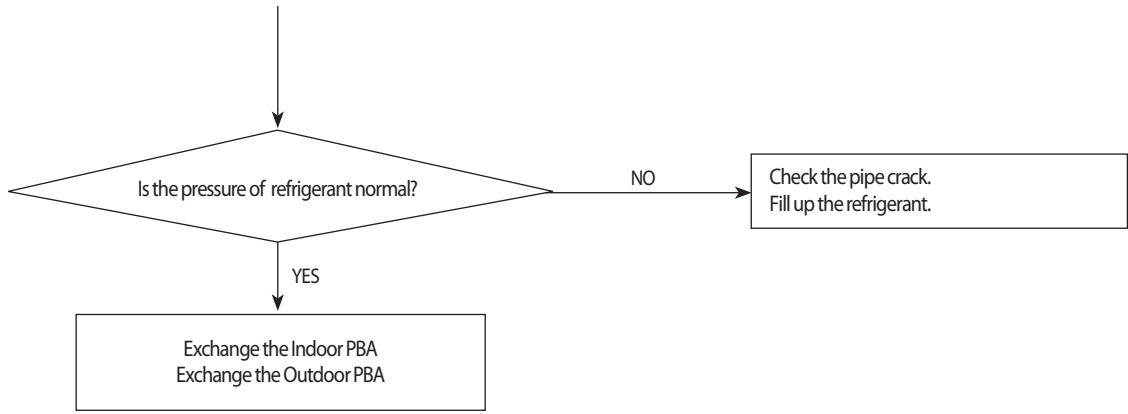

## 10-2-24 No power outdoor (Initial Diagnosis) (Not displayed)

### 1. Checklist :

- 1) Is input power normal?
- 2) Is AC power linked correctly? (L,N,E)
- 3) Is mis-wiring between communication wire and Power wire?
- 4) Is mis-wiring between Main PBA and SMPS PBA wire?
- 5) Is input voltage of SMPS AC in Main PBA (CN150) normal?
- 6) Is the voltage of SMPS DC in Main PBA (CN151,CN152) normal?

### 2. Troubleshooting procedure

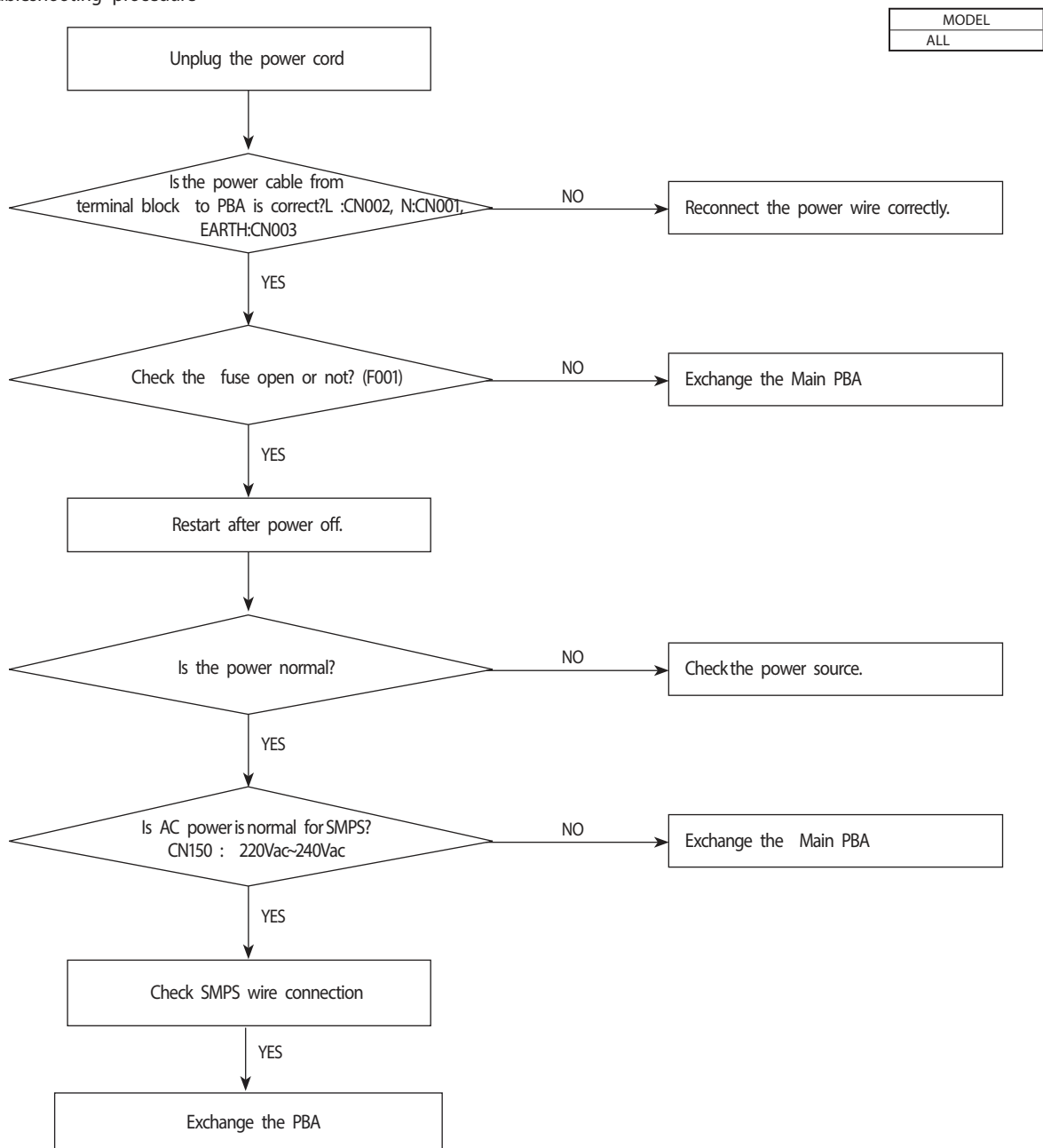

## 10-2-25 No power outdoor (Initial Diagnosis) (Not displayed)

### 1. Checklist :

- 1) Is input power normal?
- 2) Is AC power linked correctly? (L,N,E)
- 3) Is mis-wiring between communication wire and Power wire?
- 4) Is input voltage of SMPS DC-link capacitor("CE101") normal?
- 5) Is the voltage of SMPS DC normal?

### 2. Troubleshooting procedure

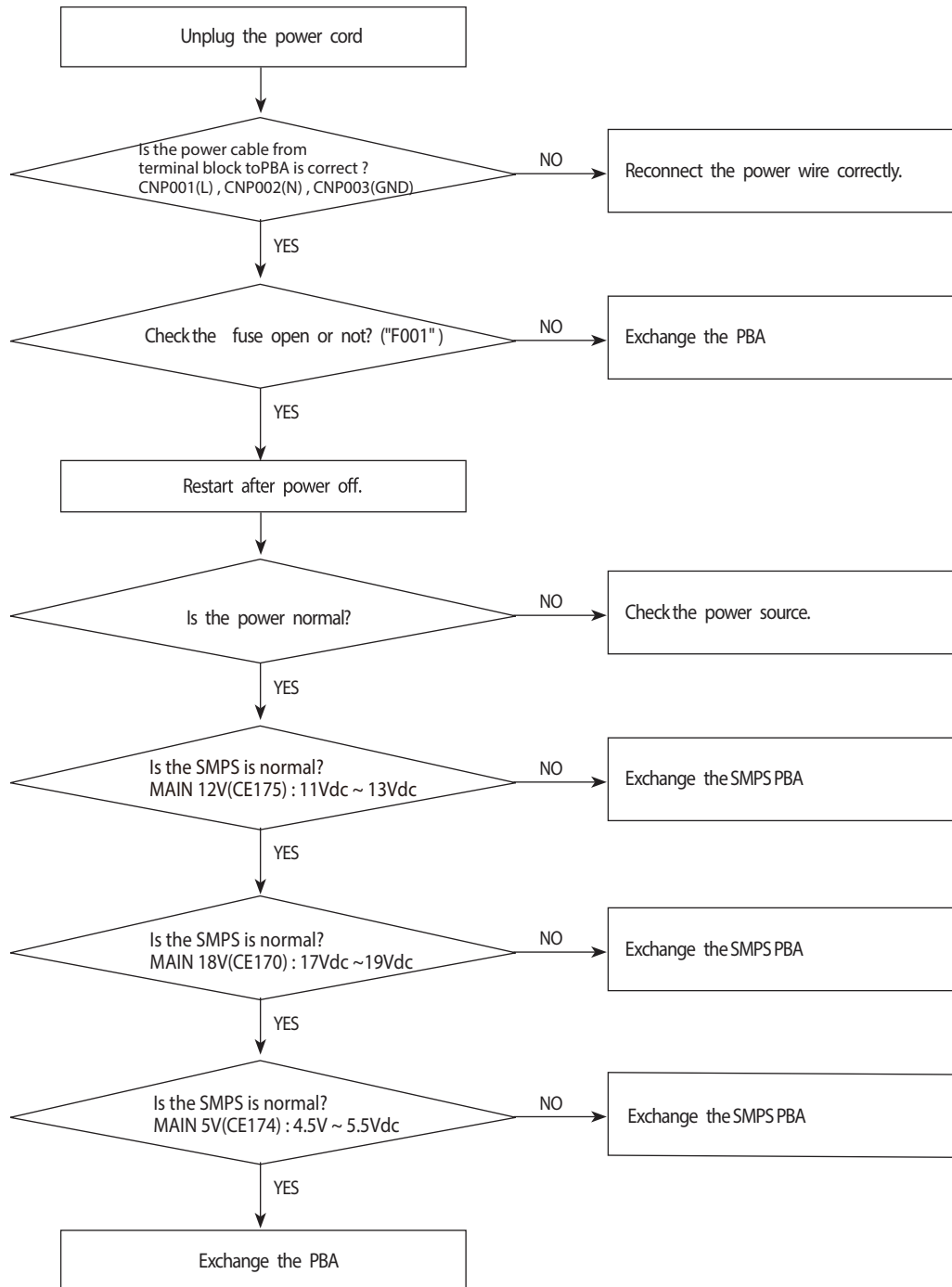

## **10-2-26 When the remote control is not receiving**

### 1. Checklist :

- 1) Check if the connector was normally assembled.
- 2) Check the battery in remote control
- 3) All the lights out and check again : Change electronic typed to a fluorescent light
- 4) Put the set in operation and check the voltage of display PBA
- 5) Replace the display PBA

## 10-2-27 EEV or Valve Close error-Self diagnosis

### Indoor display

3-LED DISPLAY			7-SEG DISPLAY	DESCRIPTION
LED1	LED2	LED3		
◎	○	◎	E422	EEV or Valve Close error-Self diagnosis

### Outdoor display

●	●	○	EEV or Valve Close error-Self diagnosis
---	---	---	---

● LED ON    ◎ LED BLINKING    ○ LED OFF

#### 1. Checklist :

- 1) Is the position of indoor Eva\_in sensor normal?
- 2) Check the pipe crack
- 3) Check the EEV valve connection("CN701") in Outdoor unit
- 4) Check the refrigerant was charged

#### 2. Troubleshooting procedure

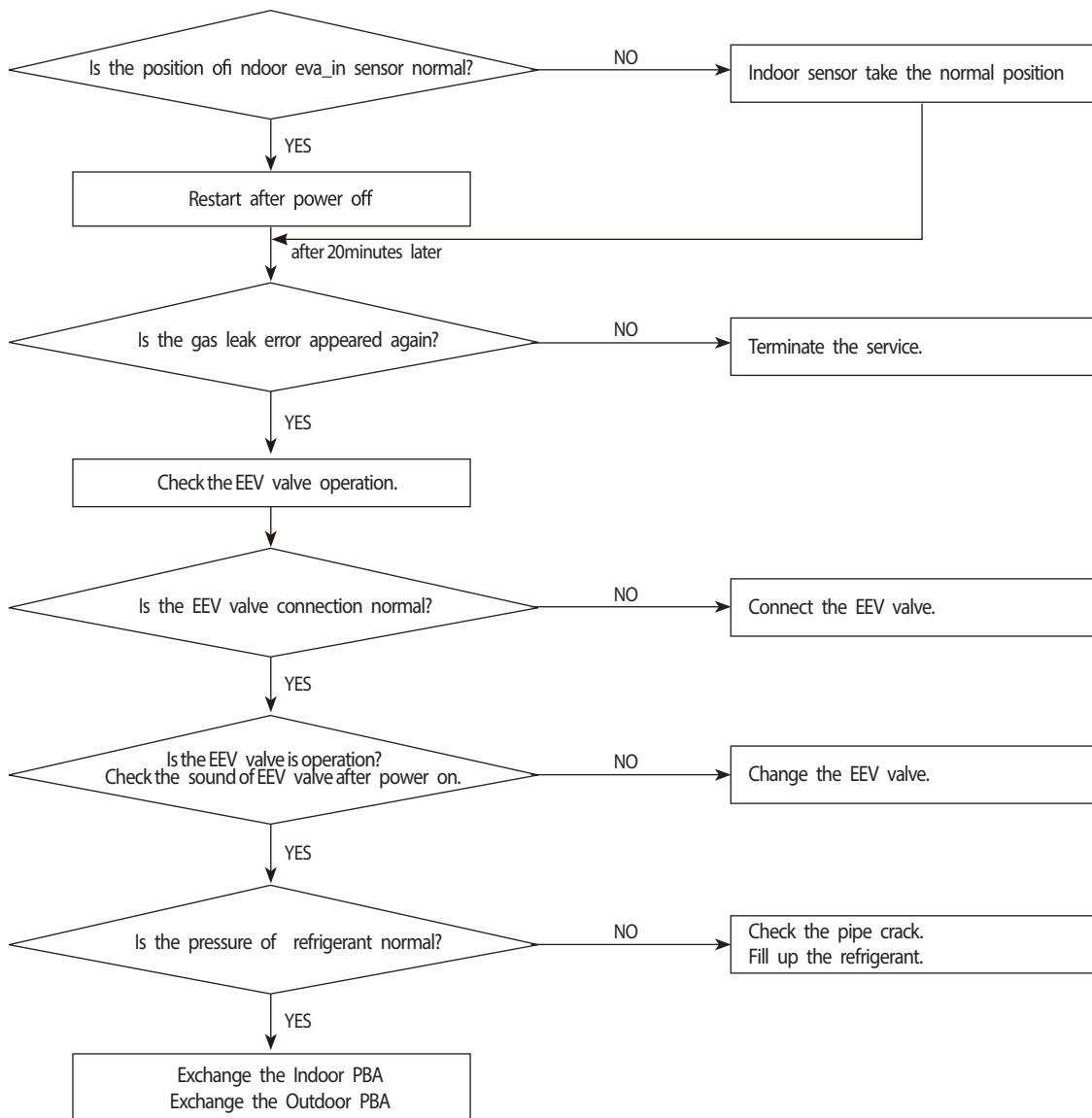

## 10-2-28 Smart Install error

### 1. Checklist :

- 1) Check the leakage region.(Use leakage detection liquid or soapy water)
- 2) When leakage region is found from service valve and piping connection flare nut part : After the related measures to check the refrigerant supplements and operation.
- 3) If the leakage region is pipe welding part : Weld leakage region after refrigerant gas release.(Brass parts should only apply)
- 4) If the leakage region is surface area (Heat exchanger or pipe welding region is not) : Replace parts.
- 5) Check the PBA Relay
  - Display of indoor unit : Ensure that the operating pilot lamp has been lighted.
  - Ensure that the Relay input voltage of indoor unit PBA is normally.(If the PBA is defective, replace)

### 2. Troubleshooting procedure

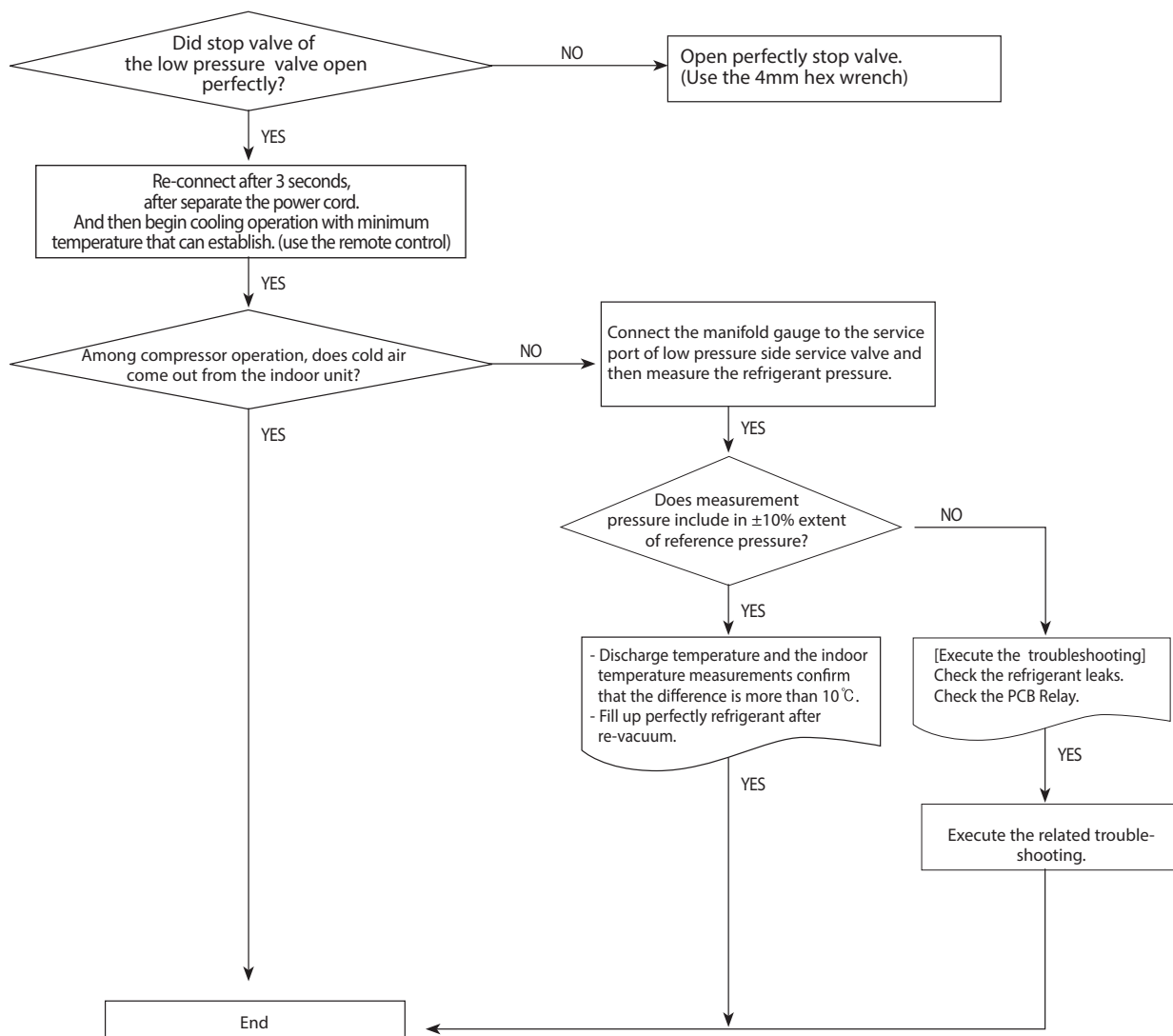

### 10-2-31 Pre-inspection Notices

1. Check if you pulled out the AC power plug when you eliminate the PCB or front panel
2. Don't hold the PCB side not impose excessive force on it to eliminate the PCB
3. Don't pull the lead wire but hold the whole housing to connect or disconnect a connector to the PCB
4. In case of outdoor PCB disassembly, check first the complete discharge of condenser after 1 minute power off

### 10-2-32 Inspection procedure

1. Check connector connection and peeling of PCB or bronze coating pattern when you think the PCB is broken
2. The PCB is composed of 3 parts
  - Indoor Main part : MICOM and surrounding circuit, relay, fan motor sensing and driving circuit, temperature sensing circuit power circuit of SMPS, buzzer circuit. Communication circuit
  - Display part : LED lamp, Switch, Remote-control module
  - Inverter Main part : MICOM and surround circuit, fan motor sensing and driving circuit, compressor driving circuit power circuit of SMPS, PFC control circuit, 4way circuit, communication circuit, Main part : EEV control circuit , Temperature sensing circuit, Communication. circuit OPTION( HEATER , DRED)

### 10-2-33 Indoor detailed inspection procedure

No	procedure	Inspection Method	Cause
1	Plug out and pull the PCB out of the control box Check the PCB fuse	1) Is 1st fuse disconnected? 2) Is 2nd fuse disconnected?	. Over current . Indoor Fan motor short . AC part and pattern short of Indoor PBA
2	Supply power If the operating lamp twinkles at this time , the above 1)~3) have no relation	Check the power voltage	
		1) Is the BD71 input voltage 200Vac~240Vac?	. Power cord is fault, Fuse open, Wrong Power cable Wiring, AC part is faulty
		2) Is the voltage between both terminal of IC02 pin #1-#2 12Vdc?	. Switching Trans of Power circuit is faulty
3	Press the ON/OFF button 1. Fan speed(high) 2. Continuous Operation	3) Is the voltage between both terminal of IC02 pin #2-#3 5Vdc?	. Power circuit is faulty, Load short
		1) Is the voltage over AC 180V being imposed on terminal #3-#5 of fan motor connector (CN72)?	. Fan motor of the indoor is faulty
		2) The fan motor of the indoor unit doesn't run	. Fan motor connector(CN72) is faulty
		3) The power voltage between terminal #3-#5 of the connector(CN72) is 0V	. PBA is faulty

10-2-34 Outdoor detailed inspection procedure

No	procedure	Inspection Method	Cause
1	Plug out and pull the PCB out of the control box Check the PCB fuse (Wait 3 minutes after power off)	1) Is 1st fuse disconnected? 2) Is indoor PBA faulty?	. Over current . AC part and pattern short of Indoor PBA . AC part and pattern short of Outdoor PBA
2	Check the Wiring	1) Is the Compressor wire connected clockwise? 2) Is the Reactor wire connected normal? 3) Is the Fan wire connected normal? 4) Is the 4way wire connected normal? 5) Is the sensor wire connected	. Wrong assembly . Installation(service) condition is bad
3	Supply power and operate the set (Use Remote-control, button in indoor set)	Check the power voltage	
		1) Is the voltage between Terminal block "L", "N" 220V ~ 24VAC?	. Power cord is faulty, Indoor PBA fault, Wrong Power cable Wiring
		2) Is the PFC050(#3-#4) input voltage 200Vac~240Vac?	. L,N,E wire wrong wiring (Terminal Block-PBA) . Fuse open . PT 021 OPEN . RY021, RY022 is faulty . Inverter Micom(IC501)error
		3) Is the CE151 voltage 280Vdc~320dc?	. Power circuit is faulty . Load short
		3) Is the CE101 voltage 280Vdc~320dc?	. PFC050 is faulty . Reactor wire is wrong connection
		4) Is the SMPS is normal? MAIN 12V(CE175) : 11Vdc ~ 13Vdc	. Switching Trans of Power circuit is faulty
		5) Is the SMPS is normal? MAIN 18V(CE170) : 17Vdc ~19Vdc	. Switching Trans of Power circuit is faulty
6) Is the SMPS is normal? MAIN 5V(CE174) : 4.5V ~ 5.5Vdc	. Switching Trans of Power circuit is faulty . Load short		
4	Check the LED lamp display	1) Normal : RED on, GRN blink, YEL off 2) Abnormal - All off : check no power - abnormal display : check error mode	. L,N,C wire wrong wiring . Outdoor PBA is faulty



## 10-3 Main Part Inspection Method

Part	Breakdown Inspection Method			
<b>Room Temperature Sensor</b>	Measure resistance with a tester			
	Normal	At the normal temperature 37kΩ~ 8.3kΩ(-7°C~+30°C)		
	Abnormal	∞, 0Ω . . . Open or Short		
<b>Room Fan Motor</b>	Measure the resistance between terminals of the connector (CN72) with a tester.			
	Normal	At the normal temperature (10°C ~ 30°C)		
		Compare terminal	Resistance	Remark
		Yellow, Blue	404.4Ω ± 10%	Main
Yellow, Red	340Ω ± 10%	Sub		
Abnormal	∞, 0Ω . . . Open or Short			
<b>Stepping Motor</b>	Measure the resistance between the red wire and each terminal wire with a tester.			
	Normal	About 300Ω at the normal temperature (20°C ~ 30°C)		
	Abnormal	∞, 0Ω . . . Open or Short		

# 11. Block Diagram

## 11-1 Indoor Unit

\* : OPTION

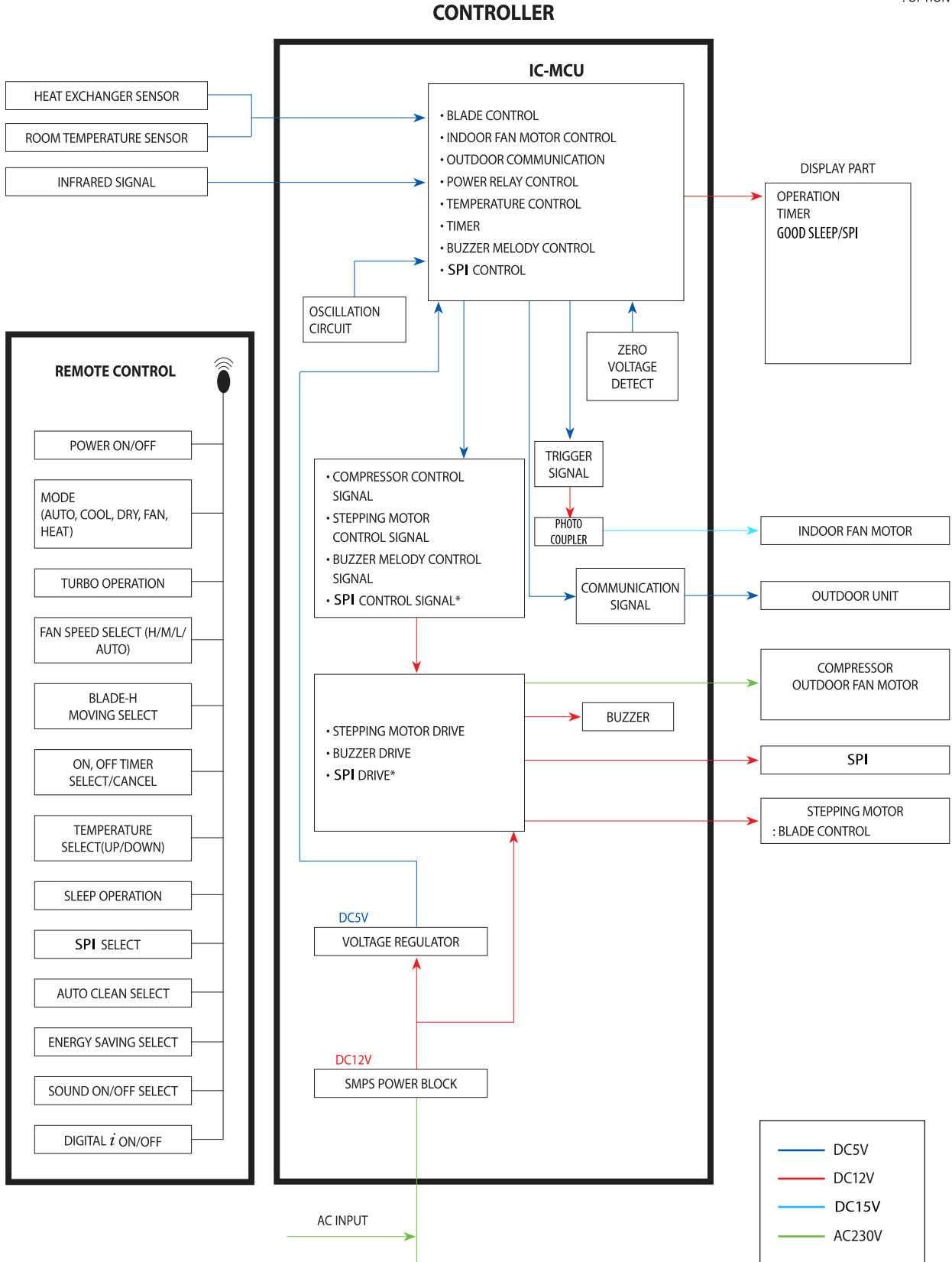

# 11-2 Outdoor Unit

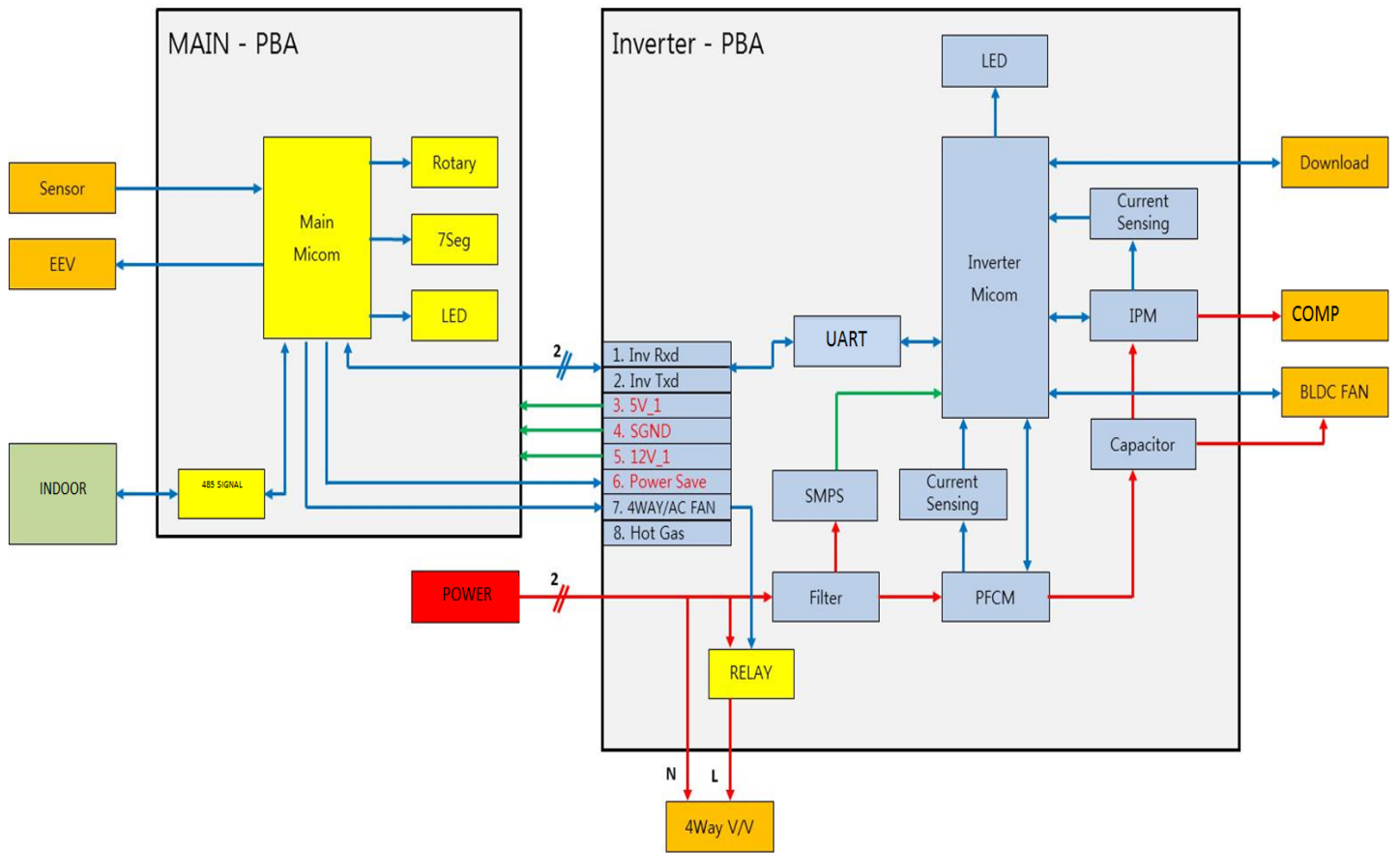

- DC3.3V
- DC5V
- DC12V
- DC15V
- DC325V
- AC230V

# 12 .Reference Sheet

## Index for Model Name

\* Project model code for overseas from 2007(For RAC Export Models)

Model Code

<b>AR</b>	<b>12</b>	<b>N</b>	<b>X</b>	<b>P</b>	<b>DP</b>	<b>WK</b>	<b>N</b>	<b>EE</b>
(1)	(2)	(3)	(4)	(5)	(6)	(7)	(8)	Buyer

(1) Model	
AR	RAC
AJ	FJM
AC	CAC

(2) Capacity	
<input type="checkbox"/>	X 1,000 Btu/h (2digits)

(3) Year	
F	2013
H	2014
J	2015
K	2016
M	2017
N	2018

(4) Inverter type	
S	HP, R410A
X	HP, R32

(5) Feature	
S	Virus Doctor
F	No Virus Doctor
P	Wi-Fi + Virus Doctor
W	Wi-Fi

(6) Series	
DP	A3050 Better
NA	AR5000 2 <sup>nd</sup>
SA	AR5000 1 <sup>st</sup>
FB	AR9000
HB	New Boracay
PE	Maldives

(7) Color	
WT	Jungfrau White Pearl
WU	Vivaldi White
GM	PM Gray
SN	Urban silver
WQ	DA White
WK	DA White

(8) Product	
N	Indoor
X	Outdoor
/	Set

(9) Buyer	
EE	Sweden
EU	Europe

## 12-2 Low Refrigerant Pressure Distribution

**Note :** Please measure the refrigerant pressure after the air conditioner operates on testing cooling mode during more than 10 minutes.

- Indoor Temp. Variation : 20°C ~ 32°C
- Outdoor Temp. Variation : -5°C ~ 45°C

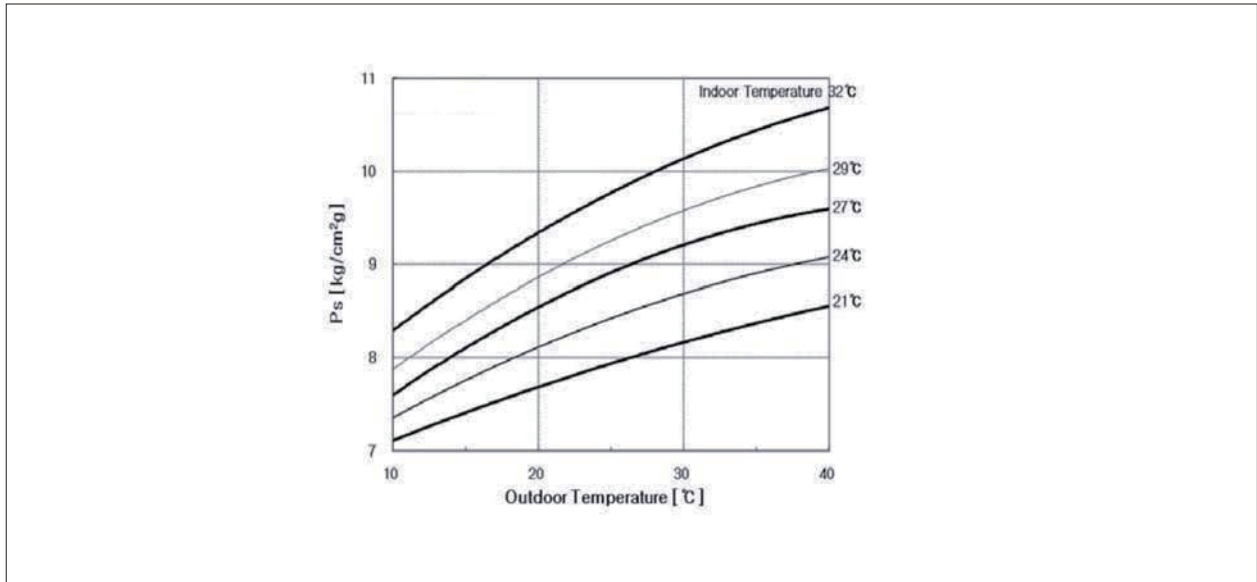

## 12-2 Pressure & Capacity mark

### ■ Power/Heat

W	cal/s	kcal/h	Btu/h	HP	kg.m/s	lb.m/s
1	0.23885	0.85985	3.4121	0.001341	0.10197	0.73756
4.1868	1	3.6	14.286	0.0056146	0.42693	3.088
1.163	0.27778	1	3.9683	0.0015596	0.11859	0.85778
0.29307	0.06999	0.252	1	3.9302x10 <sup>-4</sup>	0.029885	0.21616
745.7	178.11	641.19	2,544.4	1	76.04	550
9.8067	2.3423	8.4322	33.462	0.013151	1	7.233
1.3558	0.32383	1.0658	4.6262	0.0018182	0.13826	1

## 12-3 Pressure & Capacity mark

---

### ■ Power/Heat

W	cal/s	kcal/h	Btu/h	HP	kg·m/s	lb·m/s
1	0.23885	0.85985	3.4121	0.001341	0.10197	0.73756
4.1868	1	3.6	14.286	0.0056146	0.42693	3.088
1.163	0.27778	1	3.9683	0.0015596	0.11859	0.85778
0.29307	0.06999	0.252	1	$3.9302 \times 10^{-4}$	0.029885	0.21616
745.7	178.11	641.19	2,544.4	1	76.04	550
9.8067	2.3423	8.4322	33.462	0.013151	1	7.233
1.3558	0.32383	1.1658	4.6262	0.0018182	0.13826	1

## 12-4 Q & A for Non-trouble

Classification	Class	Description
Cooling	Q	<b>The cooling is weak.</b>
	A	When it is hot outside, its cooling capacity decreases due to the increase of the ambient temperature. When the dust filter gets blocked or warm outside air gets in, the cooling capacity will decrease. So, make sure to clean the dust filter frequently, prevent heat loss by closing the doors and insulate the cooling area by using curtains, blinds, shades or window tinting.
	Q	<b>The cooling is good generally. But, it gets weak when it is considerably hot.</b>
	A	It occurs when the outdoor unit is exposed to direct sun light and heat-up air is not ventilated well. So, set up a sunblind over the outdoor unit and keep stuff away from the unit to increase the ventilation. When the cooling capacity decreases during a heat wave, clean the heat exchanger of the outdoor unit or spray some cold water to the heat exchanger to increase the cooling capability.
	Q	<b>The cooling is weak. Does it need refrigerant charging?</b>
	A	It is not correct charging refrigerant regularly. Except that you have moved in several times or the connection pipes are broken, the refrigerant does not run low. So, when refrigerant is additionally charged, it could be costly and cause a product's failure. When the refrigerant leaks, all of it will escape in a short time resulting in cooling failure and no water coming out of the drain hose. So, if water comes out from the drain hose, it indicates the normal operation of the product and it does not need refrigerant charging.
	Q	<b>It fails to do cooling.</b>
	A	When the air conditioner is set to Ventilation or the desired temperature is set higher than the current temperature, it fails to do cooling. In this case, select Cooling or set the desired temperature lower.
Leakage	Q	<b>It floods the floor.</b>
	A	Place the drain hose properly. When it is not placed properly, the drain water would flow back flooding the floor. So, straighten out the drain hose for the water to be drained well.
	Q	<b>Water drips at the drain connection (service valve) of the outdoor unit.</b>
	A	When a glass bottle is taken out of the refrigerator, moisture gets condensed on its surface due to the temperature differences. The same principle applies to the air conditioner. When cold refrigerant goes through the copper tube, moisture gets condensed on the surface of the tube and the connection areas. To prevent the water condensation, the pipes are insulated. But, the connection areas of the outdoor unit are not insulated for the purpose of maintenance or repair, and water gets condensed due to the temperature differences and drips down. Generally, it evaporates right away. But, when it drips much during muggy days, put a water pan on the floor.
	Q	<b>It leaks even though a drain pump is used.</b>
	A	It occurs when the drain pump is plugged out or it is out of order. Check the power of the drain pump and the position of the drain hose, and when the pump is faulty, contact the drain pump manufacturer. Samsung Electronics do not manufacture drain pumps. So, we are not able to correct the drain pump problems.
Smells	Q	<b>Whenever the air conditioner is turned on, it irritates my eyes and gives me a headache.</b>
	A	There are no components in the air conditioner irritating the eyes and sending out chemical smells. But, when the air conditioner is turned on, other smell sources are sucked into the air conditioner and get out of it. So, find and root out the smell sources. Generally, it occurs at a interior renovated place, a pharmacy, a gasoline handling place, a tire shop, a second-hand book shop or an electronic component handling place; when its chemical or musty smells are sucked in and sent out, it can be misled that the air conditioner generates them. So, find and root out the problem or refresh the room frequently.

Classification	Class	Description
Smells	Q	<b>Whenever the air conditioner is turned on, it stinks.</b>
	A	There are no components in the air conditioner sending out chemical smells. But, when the air conditioner is turned on, other smell sources are sucked into the air conditioner and get out of it. So, find and root out the smell sources. Generally, when the drain hose is taken out to the washing room or there are sources of smells such as a diaper bin, a shoe shelf or a socks bin, bad smells generate. Also, it occurs where glass cleaners or air fresheners are used; when they are sucked in interacting with dusts and moistures inside, bad smells generate. These kinds of organic materials noxious to human bodies. So, we recommend against the use of them.
	Q	<b>Whenever the air conditioner is turned on, it smells sour.</b>
	A	When the room is papered recently, its paste smells would be sucked inside. Also, when the air conditioner is installed in the study room of young boys loving sweat-generating activities such as the basketball, excessive sweats evaporate and get sucked into the air conditioner resulting in bad smells. So, find and root out the problem or refresh the room frequently.
	Q	<b>Whenever the air conditioner is turned on, it smells musty.</b>
	A	It is due to the improper keeping of the product after its use. When keeping the product, dry up the inside with the operation of Ventilation to prevent must. When the product is kept without drying up the inside with Ventilation, mold would grow inside resulting in must. So, open the windows and switch on the Ventilation function to get rid of the saturated smell inside.
	Q	<b>Whenever the air conditioner is turned on, it sends out bad smells such as stale smells.</b>
	A	It occurs generally when there are pet animals in the house. Their smells stay at the same place. But, when the air conditioner is turned on, the air gets circulated resulting in the circulation of the smells. So, find and root out the problem or refresh the room frequently.
	Q	<b>It sends out bad smells.</b>
A	When the air filter is filthy, it could send out bad smells. So, clean the filter and ventilate the room with the windows open while operating the Ventilation function.	
Operation	Q	<b>It won't start.</b>
	A	There is a power failure or it is plugged out. Also, check if the power distribution panel is switched off.
	Q	<b>It goes off during operation.</b>
	A	When the hot air does not escape properly, it goes off during operation. It occurs when it does not ventilate properly because the outdoor unit is covered, the back of the outdoor unit is blocked by a cardboard or a plywood panel, and the front of the outdoor unit is blocked by the closed window or other obstacles. Clear the above obstacles from the outdoor unit.
	Q	<b>It generally works properly. But, when it's considerably hot, it goes off during operation.</b>
	A	It occurs when the outdoor unit is exposed to direct sunlight and the hot air does not escape properly. Set up a sun blind over the outdoor unit and clear the neighboring obstacles from the outdoor unit to provide good ventilation. When it goes off frequently during a heat wave, it would prevent the turn-off and increase the cooling capacity cleaning the outdoor unit or spraying some water to the heat exchanger.
Q	<b>The remote controller won't operate.</b>	
A	When the batteries run out or the transmitter or receiver of the remote controller is blocked by obstacles, change the batteries or keep the obstacles away from the controlling area. Also, the remote controller may not work under intensive light from a 3-wave length lamp or a neon sign due to the EMI. In this case, take the remote controller closer to the receiver.	



Classification	Class	Description
Installation	Q	<b>Who installs the air conditioner? (Relocation/Re-installation)</b>
	A	When relocating or re-installing the air conditioner, make sure to contact Samsung Electronics Service Center or Authorized Service Agent and have them to do the job. (If not, it could cause personal injury or product damage.) The cost for the relocation/re-installation of the air conditioner is subject to the customer's expense. There is a cost table. But, our service engineer needs to visit to total up the cost correctly. When you move in, make sure to contact Samsung Electronics Service Center or Authorized Service Agent in advance to streamline the process.
	Q	<b>Is it possible to install the outdoor unit outside?</b>
	A	It is possible to install it at a designated place in the apartment or on the rooftop nearby. But, it's illegal hanging an angle iron case with the outdoor unit in it outside the apartment. Also, it is illegal obstructing passers-by with the outdoor unit installed outside.
	Q	<b>What can be done to install the outdoor unit facing the road because it is a commercial building?</b>
	A	The following is an excerpt from Building Code going into effect from JUNE 1st 2005. "The exhaust pipe of a cooling or ventilation facility installed in a building adjacent to the streets of commercial or residential areas shall be installed higher than 2 m to prevent the exhaust air from blowing directly to passers-by and the current facilities shall be corrected by MAY 31st 2005." So, please install it higher than 2 m or not to blow the hot exhausting air directly to passers-by.
	Q	<b>What about installing a windscreen during installation not to blow hot air directly to passers-by?</b>
A	When the hot air from the front of the outdoor unit is blocked, the product's performance will be affected and it will fail to operate properly. So, keep it at least 300mm away from its surrounding walls and give it good ventilation.	

## 12-5 Cleaning /Filter Change

### 12-5-1 Cleaning your Air Conditioner

To get the best possible use out of your air conditioner, you must clean it regularly to remove the dust that accumulates on the air filter.

#### Removing the Air filter

There is a hole on the bottom right side of the filter. Put your finger in that hole to get a grip on the filter and slightly push it up to release the hooks from the bottom side. Then, pull it down to remove the filter from the main body.

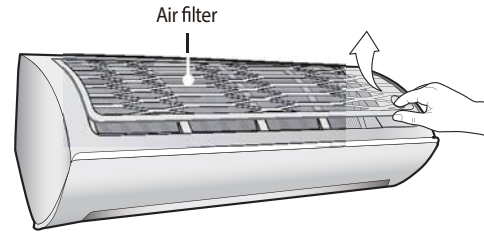

#### Cleaning the air filter

Washable foam based air filter captures large particles from the air. The filter is cleaned with a vacuum or by hand washing.

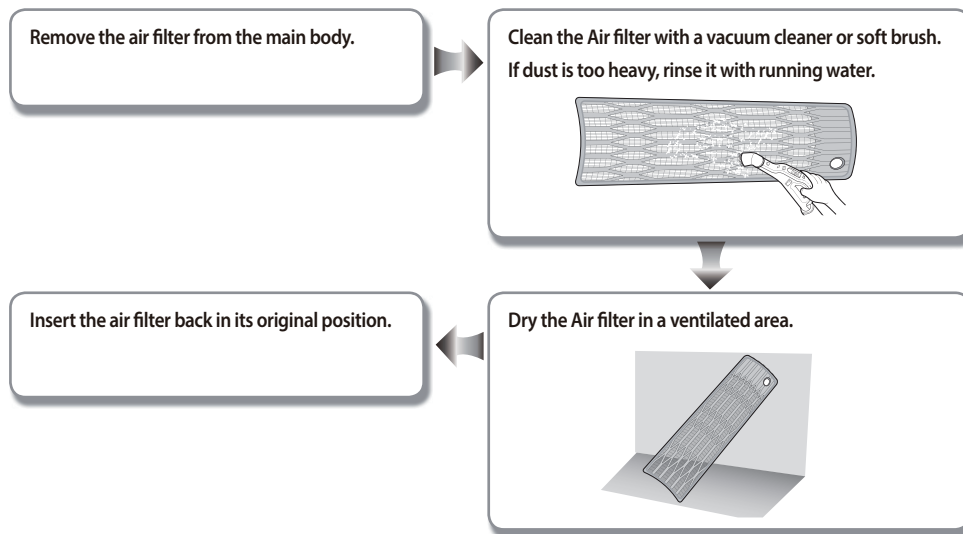

- Clean the Air filter every 2 weeks. Cleaning term may differ depending on the usage and environmental conditions. In dusty area, clean it once a week.
- If the Air filter dries in a confined (or humid) area, odors may generate. If it occurs, re-clean and dry it in a well-ventilated area.
- When the filter clean reminder is on, please press the 2nd F button and then press the ECO Run button on remote controller.

## 12-6 Installation

---

### 12-6-1 Before Installation

Keep the air conditioner outlet and inlet free from its surroundings.  
In case of installation, keep the symmetry and fix it to prevent vibration.  
The pipe length shall meet the standard as far as possible.

### 12-6-2 Installation Procedure

#### ■ Location

Install the product in an area to guarantee the best cooling effect, convenience of piping and electric work, and inexistence of vibration or wind.

#### ■ Wall Drilling

Drill the wall downward in a diameter of 60 to 65mm.

#### ■ Fixing Indoor Unit & Outdoor Unit

Fix the air conditioner indoor unit securely to the wall. Secure the outdoor unit in a suitable position.

#### ■ Pipe Spooling & Connecting

You shall cut the pipe with a pipe cutter and grind all the burrs of the cut surface.  
Pipe expansion may continue until the pipe surface becomes uneven or torn apart.  
Be sure to use a torque wrench to tighten pipes or flare nuts.

<Torque & Depth>

Outer Diameter(D)	Torque(kgf-cm)	Depth(A)
6.35mm(1/4")	140~170	1.3mm
9.52mm(3/8")	250~280	1.8mm
12.70mm(1/2")	380~420	2.0mm
15.88mm(5/8")	440~480	2.2mm
19.05mm(3/4")	990~1,210	2.2mm

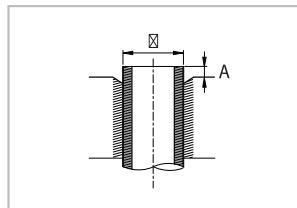

#### ■ Leak Test

Put an inert gas like nitrogen in the outdoor unit pipe and put soap bubbles or other test liquids on the pipe surface for the leak test.

#### ■ Drain Hose Connecting

Install the drain hose downward to drain water naturally. Be sure to pour water into the hose to check if it drains well.

#### ■ Electric & Earth Work

Electric and earth work shall meet the "Electric Facility Technology Standard" and the "Internal Wire Regulation" of the Electric Business Laws.

#### ■ Inspection & Trial Run

Upon completion of the tests, you shall make a trial run while you explain the main functions of the air conditioner to finish the installation.

## 12-7 Installation Diagram of Indoor Unit and Outdoor Unit

### 12-7-1 Air-Purge Procedure

- 1) Connect each assembly pipe to the appropriate valve on the outdoor unit and tighten the flare nut.



- 2) Connect the charging hose of low pressure side of manifold gauge to the packed valve having a service port as shown at the figure.



- 3) Open the valve of the low pressure side of manifold gauge counter-clockwise.



- 4) Purge the air from the system using vacuum pump for about 30 minutes.
  - Make sure that pressure gauge show  $-0.1\text{MPa}(-76\text{cmHg})$  after about 30 minutes.
  - This procedure is very important in order to avoid gas leak.
  - Turn off the vacuum pump.
  - Close the valve of the low pressure side of manifold gauge clockwise.
  - Remove the hose of the low pressure side of manifold gauge.



- 5) Set valve cork of both liquid side and gas side of packed valve to the open position.



- 6) Mount the valve stem nuts and the service port cap to the valve, and tighten them at the torque of  $183\text{kgf}\cdot\text{cm}$  with a torque wrench.



- 7) Check for gas leakage.
  - At this time, especially check for gas leakage from the 3 way valve's stem nuts, and from the service port cap.

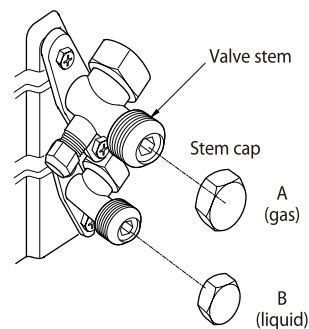
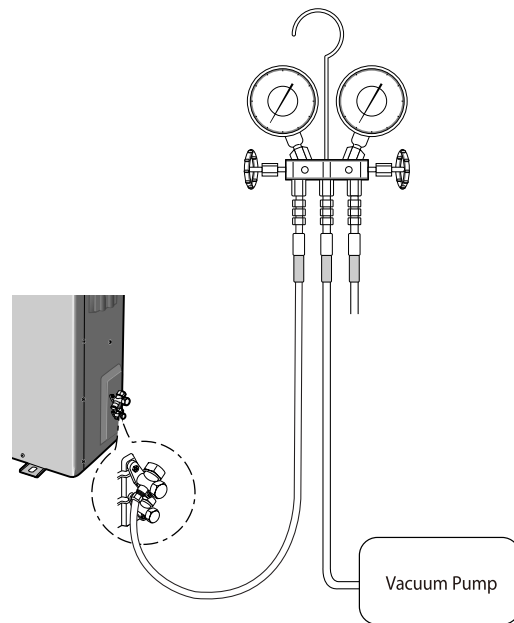
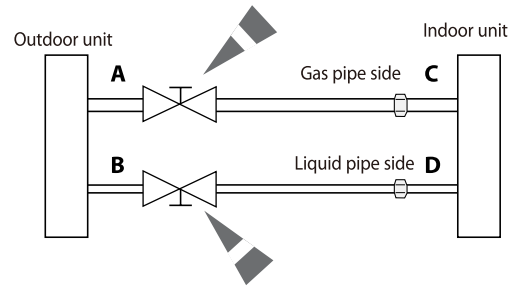

## 12-7-2 "Pump down" Procedure

Pump down will be carried out when an evaporator is replaced or when the unit is relocated in another area.

1) Remove the caps from the 3 way valve and the 3-Way valve.



2) Turn the 3-Way valve clockwise to close and connect a pressure gauge (low pressure side) to the service valve, and open the 3 way valve again.



3) Set the unit to cool operation mode.  
(Check if the compressor is operating.)



4) Turn the 3-Way valve clockwise to close.



5) When the pressure gauge indicates "0" turn the 3-Way valve clockwise to close.



6) Stop operation of the air conditioner.



7) Close the cap of each valve.

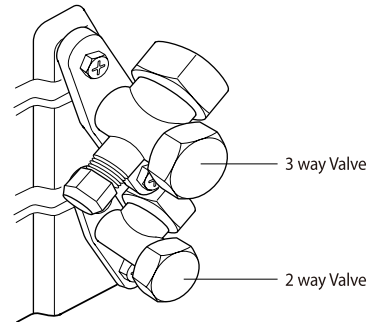

### Remarks

#### Relocation of the air conditioner

- Refer to this procedure when the unit is relocated.
- Carry out the pump down procedure (refer to the details of 'pump down').
- Remove the power cord.
- Disconnect the assembly cable from the indoor and outdoor units.
- Remove the flare nut connecting the indoor unit and the pipe.
- At this time, cover the pipe of the indoor unit and the other pipe using a cap or vinyl plug to avoid foreign material entering.
- Disconnect the pipe connected to the outdoor unit.  
At this time, cover the valve of the outdoor unit and the other pipe using a cap or vinyl plug to avoid foreign material entering.
- Make sure you do not bend the connection pipes in the middle and store together with the cables.
- Move the indoor and outdoor units to a new location.
- Remove the mounting plate for the indoor unit and move it to a new location.

### 12-7-3 POWER SUPPLY

<b>Working Voltage</b>	176V ~ 264V
<b>Voltage Imbalance</b>	Within a 3% Deviation from Each Voltage at the Main Terminal of Outdoor Unit
<b>Starting Voltage</b>	Higher than 80% of the Rated Voltage

### 12-7-4 WORKING RANGE

Cooling

Item	Lower (°C)	Upper (°C)	Rated (°C)
Outdoor	-15	46	35
Indoor	16	32	27

Heating

Item	Lower (°C)	Upper (°C)	Rated (°C)
Outdoor	-25	24	7
Indoor	8	27	20

