



WOOD - FIRED HOT WATER GASIFYING BOILER



MA 15, MA 20, MA 25

MA 31, MA 40, MA 49, MA 80

With an exhaust fan and CONTROL UNIT ST 81 zPID

BOILER OPERATION AND MAINTENANCE MANUAL

MAGA s.r.o., S. Kollára 86
979 01 Čerenčany – Rimavská Sobota
Slovakia

Tel / fax:

+421 47 56 34 798

E-mail:

sales@magasro.sk

Web:

<http://www.magasro.sk>

Thank you for buying our product!

SO THAT YOU REMAIN SATISFIED WITH OUR PRODUCT, WE RECOMMEND THAT YOU FOLLOW THESE

**FUNDAMENTAL PRINCIPLES FOR
LONG LIFESPAN AND SUSTAINABLE PROPER OPERATION
OF THE BOILER**

1. Use only dry wood fuel with max. 20 percent moisture content – (2 years old wood).
2. During the process of gasification of solid wood some tar and other condensates (acids) may accumulate in the fuel bin. That is why a four-way mixing valve or a Laddomat needs to be installed right next to the boiler. We adjust the mixing valve in such a way that the operating temperature of the water inside the boiler is between 75 and 90 °C (167 – 194 °F). The prescribed minimum return water temperature is 60 °C (140 °F).
3. When a circulating pump is used, the heating medium's temperature gradient must be ensured of at least 15 – 20 °C and a minimum return water temperature of 60 °C (140 °F). The pump must be connected to the thermo switch in such a way that it only operates when the required minimum temperature is reached.
4. The boiler must not be continually operated at an output capacity less than 60 % of its rated capacity.
5. For correct and safe operation of the boiler the following principles must always be observed:
 - Boiler cleaning on a regular basis during a heating season;
 - Thorough cleaning of the boiler after the end of a heating season;
 - Required chimney draught (sufficient combustion products velocity)
 - Good thermal insulation of the chimney;
 - Regular inspections of chimney draft (chimney-sweeper).
6. It is recommended to install a boiler in a system with an accumulative tank.

WARNING – If the above instructions are not followed the life of the boiler's body and the ceramic fireproof insulation bricks may be substantially reduced as a result of low temperature corrosion. The boiler body may become badly corroded as early as within two years.

1. Purpose of Use

The MA hot-water boiler is intended for heating homes and other types of buildings. The boiler is designed exclusively to work on burning wood. Any dry wood such as chopped logs or wood chips with maximum length of 500 mm (MA 15 – 350 mm, MA 80 – 650 mm) can be used as fuel for this boiler. Logs with larger diameters can be used as well. If so done, the boiler's rated output capacity will decrease and the period of burning will extend.

A large wood storage bin will help replace and eliminate the most laborious operations associated with the preparation of wood fuel – i.e. the sawing and cutting of logs into pieces of an appropriate size. This practice will save not only physical exertion, but also time necessary for the work.

2. Technical Parameters

Boiler Type		MA 15	MA 20	MA 25
Output Capacity	kW	15	20	25
Maximum Output Capacity	kW	18	22	27
Heating Surface	sq. m.	1,45	1,75	1,95
Fuel Bin Volume	cubic dm (dm ³)	75	110	125
Operating Draught	Pa	10-15	10-15	10-15
Maximum Operating Water Gauge Pressure (MPa)		0,25	0,25	0,25
Boiler Weight	kg	310	350	380
Exhaust Socket Diameter	mm	159	159	159
Boiler Height	mm	1120	1120	1210
Boiler Depth	mm	1000	1140	1140
Boiler Width	mm	570	570	570
Boiler Efficiency at Rated Capacity	%	85	85	85
Prescribed Type of Fuel		Dry wood with calorific value of 15 – 17 MJ . kg ⁻¹ Maximum water contents – 20 %		
Average Fuel Consumption	kg . h ⁻¹	4,2	5,8	6,2
Maximum length of wood logs/chips ø 60 – 200 mm	mm	350	500	500
Degree of coverage of the electric part	IP	20	20	20
Voltage	V / Hz	230/50	230/50	230/50
Fan power input	W	77	77	77

Boiler Type		MA 31	MA 40	MA 49	MA 80
Output Capacity	kW	31	40	49	75
Maximum Output Capacity	kW	33	42	52	80
Heating Surface	sq. m.	2,35	3,6	4,1	7,3
Fuel Bin Volume	cubic dm (dm ³)	140	140	190	300
Operating Draught	Pa	15-20	15-20	15-20	20-25
Maximum Operating Water Gauge Pressure (MPa)		0,25	0,25	0,25	0,25
Boiler Weight	kg	430	510	550	810
Exhaust Socket Diameter	mm	159	159	159	159
Boiler Height	mm	1210	1290	1290	1425
Boiler Depth	mm	1140	1140	1165	1380
Boiler Width	mm	620	620	730	730
Boiler Efficiency at Rated Capacity	%	85	85	85	85
Prescribed Type of Fuel		Dry wood with calorific value of 15 – 17 MJ . kg ⁻¹ Maximum water contents – 20 %			
Average Fuel Consumption	kg . h ⁻¹	7,8	9,1	9,8	18,6
Maximum length of wood logs/chips ø 60 – 200 mm	mm	500	500	500	650
Degree of coverage of the electric part	IP	20	20	20	20
Voltage	V / Hz	230/50	230/50	230/50	230/50
Fan power input	W	77	77	120	120

Note: If the maximum boiler output capacity is required, any logs with larger diameters are necessary to be cut in half or, possibly, cut in quarters.

3. Technical Description

The boiler is designed to work on burning wood. The combustion process (which is based upon power generating gasification) is obtained by passing ambient air into the firebox (furnace) with the use of an exhaust fan.

The boiler shell is made from steel plates as a welded assembly. It consists of a fuel feed hopper, which at its bottom part is equipped with a fireproof insulation brick that comprises a longitudinal opening (nozzle) for exhausting the combustion products. There is an afterburning space with ceramic tile blocks located beneath the said fireproof insulation brick. In the rear part of the boiler there is a vertical tube plate that, in its upper part, merges into a collecting duct where there is a firing valve. The collecting duct's rear part is equipped with an exhaust fan and socket for connecting the duct to the chimney.

The front face of the upper part comprises a refueling door and the lower part comprises an ash door. There is a fan located on the back side.

The outside surface of the boiler body is thermally insulated with mineral wool inserted beneath sheet metal covers of the boiler's outer shell.

The upper portion of the boiler comprises a control panel.

The boiler's construction gives the following advantages:

- the combustion process takes place at a high temperature using the function of power generating gasification;
- the combustion air is supplied through an exhaust fan;
- the combustion process is characterized with stable flame and a stable state and quality of combustion;
- the large fuel feed hopper enables the burning of separate pieces of wood with maximum length of 500 mm (MA15 – 350mm, MA 80 up to 650 mm);
- enables the burning of wood waste.

4. Operating Regulations

Boiler Preparation for Operation

Before the boiler is put into operation, it is necessary to ensure that your heating system has been filled with water (that has to be up to standard STN 07 7401:1992) and deaerated. Ceramic "U" needs to be completed and has to be placed directly under the nozzle – (see page 8). There is also an electrical box at the back side of the boiler, which has a terminal board for connection of the water pump (included socket). In the Service parameters setting (see **chapter Service manual for ST-81 zPID control unit**) you may change the temperature, from which the boiler will start to operate the water pump. The preset value is 60°C (arrange 30 - 60°C)

In order to ensure proper and safe operation, your wood-fired boiler must be operated in accordance with the instructions contained in this operating and maintenance manual. The boiler must be operated by adults only.



CAUTION

When you fire up a new boiler for the first time, condensation and discharge of the condensate from the boiler may occur - this is not because of any defect in the boiler. After a longer duration of operation the condensation will disappear.

Firing Up and Operation

Before you fire up the boiler, be sure to open the firing valve (11). To do this, pull the firing valve's draw rod (15) towards yourself until the draw rod is locked in the "B" position. Insert dry wood chips onto the fireproof insulation brick (5) through the upper door (2). The wood chips should be inserted perpendicularly to the duct (10) in such a way that a gap of about 2 – 4 cm (approx. 0.8 to 1.5 inch) should be allowed between the duct and fuel so that the duct intended to convey combustion products could not get blocked. Put some paper or wood wool on the wood chips and insert some additional wood chips and a larger amount of dry wood onto it. Open the lower door (3) and start the exhaust fan. (To start the exhaust fan, please turn **ON** the

control unit by the switch to the position **I** and press the  button two times.) Fan(4) will start to work. We can set the

temperature on the control unit to 80-85°C by pressing  or  button. We do not need to press any button to save the setting. Control unit will save it automatically up to 5 seconds.

After lighting the fire, shut the upper door (2) and wait until the fuel catches fire. Then add additional fuel (the firebox should be fully filled with wood). After the fuel catches fire, close the lower door (3), shut the firing valve (15) by pushing the firing valve's draw rod to the (A).

Control unit comes with default settings. Additional settings are explained in chapter Service manual for ST-81 zPID control unit. If the fuel burns out and water temperature decreases in the boiler, the fan and pump turns off automatically.

Note:

In boilers equipped with flue temperature sensor the fan and pump will go off by decreasing set flue temperature. In the control unit the flue sensor needs to be set to **ON**.

Output Capacity Regulation

The regulation of output capacity is performed automatically through turning on and off the fan or by adjusting the fan speed in the control unit.

Refueling

Refueling should be carried out in the following manner: - by pressing the Option button the “ **Fan 100 %** ” symbol appears. This function will start up when putting the wood into the boiler and the fan will be running at 100 % rotation speed during the T-time, which is set up in the service parameters 60 seconds (arrange 20 – 250 seconds.) After the lapse of the predetermined time the process will be finished by switching to the automatic mode. Open the firing valve (15). Wait about 5 seconds and then open the refueling door (2) slowly so that the accumulated gas could be exhausted into to chimney. Then you can open the door to the full open position. Fill the charging hopper to full capacity at all times during operation of the boiler. After the hopper is filled to its full capacity, close the door, shut the firing valve.

Boiler Cleaning

The cleaning of a boiler should be carried out as follows: Open the feeding door (2) and then sweep the ash through the slot (10) into the lower space. Small pieces of unburnt wood (i.e. wood coal) can be left in the charging hopper until the boiler is fired up next time. Open the clean-out opening (13) and clean the tube plate by taking out of the turbulators (25) and cleaning by the tube cleaner. After you open the ashtray door you can rake the ash and soot out from the ashtray.

A cleaning interval depends on the quality of fuel you use (moisture content), the intensity of heating, the chimney draught, and other specific circumstances. The boiler should be cleaned at least once a month. The lower combustion space is necessary to be kept clean. You should clean it twice a week, at the least.

Minimum once a year, we recommend to clean the wheel of the exhaust fan(4) and the air ways. We should turn off the control unit and unplug the boiler from the electricity. We can demount the exhaust fan by unscrewing 4 screws under the chimney tube (14) and take out the exhaust fan with the sheet metal plate it is mounted on. Be careful and do not break the electrical cable it is connected to the boiler. We can clean the wheel by a soft or medium brush. The we mount the fan the same way we have demounted it. Electrical cables should hang from the bottom of the fan. To clean the air ways, we must demount the front panel (26), unscrew two screws under the upper door (2) and 2 screws on the panel’s sides. Unscrew the air flap valve (7) and clean the air ways. Use a plug for the holes for air ways into the nozzle, to keep it clean from the ash from the cleaning. After cleaning, unblock the air way into the nozzle and mount the parts in the same order from the end to the beginning.

5. Heating System and Boiler Maintenance

You should check the water level in the heating system at least once in every 14 days. Refill water if necessary. Refilling must be, at all times carried out with the boiler out of operation. If, during winter season, your boiler is out of operation, there is a danger that the water remaining in the system may freeze causing damage to the system. In this case we can use an anti-freeze mixture for the heating systems. Water should be pumped out of the system in exceptional cases only. If possible, drain the water from the system for a minimum necessary amount of time. After the end of a heating season a boiler should be thoroughly cleaned, any damaged parts should be repaired or replaced with new parts.

6. Fuel

The appropriate type of fuel is dry wood with max. 20percent moisture content. Logs should be with maximum length of 500 mm (MA 15 – 350 mm, MA 80 – 650 mm) and calorific value of 15 – 17 MJ.kg⁻¹. The required dimensions of wood pieces are stated in Chapter 2 - Technical Information.

7. Chimney

The chimney flue must at all times develop a sufficient draught to be able to reliably exhaust combustion products to the outside environment. A separate independent chimney flue of proper dimensions should be installed for the chimney to function properly. The proper function of a boiler depends on the chimney draught. The chimney draught depends on the chimney’s cross section, height and the roughness of the chimney’s walls’ internal surface. The MA 25 boiler requires an operating chimney draught of 10-15 Pa.

No other appliance should be connected to the boiler’s chimney.

For the boilers MA, approximate dimensions of the boiler’s cross section are:

20 x 20 cm	Minimum height 7 m
ø 20 cm	Minimum height 8m

Exact dimensions of a chimney for this purpose in Slovakia are governed by Slovak Technical Standards STN 734201 and STN 734210. The manner in which the chimney must be connected is determined by the provisions of SR Ministry of Interior’s Decree No. 84/1997 Coll, Articles 4 and 15. For correct information, please see your national legislation and law.

8. Accessories

Scraper for sweeping pipes	1 pc
Inlet valve	1 pc
Sweeping scraper	1 pc
Operation and maintenance manual	1 pc
Warranty certificate	1 pc
Female socket for pump	1 pc

9. Electrical Connection of the Boiler to the Power Supply

The boiler is connected to the electric power supply by a three-conductor cable (triplex) with a male plug. The male electric plug is inserted into a fixed female plug with a voltage of 230 V / 50 Hz, 16 A. The female plug must be installed according to current Slovak Technical Standards. The power supply plugs must be easily accessible to personnel after the installation of a boiler.

10. Possible Malfunctions and the Method of Correcting Malfunctions

<i>Malfunction</i>	<i>Cause</i>	<i>Method of Remedy</i>
The warning lamp ("Power") does not light	<ul style="list-style-type: none">- no voltage at power supply terminal- the plug is not properly inserted in the power socket (female terminal)- bad/blown fuse- bad mains switch- bad electric power cable	<ul style="list-style-type: none">- check- check- replace- replace- replace
Your boiler is failing to give the required output capacity	<ul style="list-style-type: none">- too little water in the heating system- the heating system has not been deaerated- your boiler is not of appropriate size/capacity for your hot water/heating system- fuel of low quality, high moisture content, too large logs- poor chimney draught	<ul style="list-style-type: none">- add water- deaerate- revise the project- burn dry wood and wood waste- clean your chimney, check the connection
Too noisy fan	<ul style="list-style-type: none">- insufficiently clean boiler- the fan is clogged with dirt	<ul style="list-style-type: none">- clean the boiler- clean the fanBy blowing high pressure air through it or using a fine brush
The door is not tight fitting	<ul style="list-style-type: none">-defective caulking cord- blocked nozzle	<ul style="list-style-type: none">- replace- do not burn fine wood waste separately from larger pieces (sawdust, chips etc.)

11. Fire Protection during the Use of Heating and Heat Consuming Devices and During the Installation of Such Devices

A boiler must be installed in accordance with the STN 061008 standard – Fire Safety of Local Heating and Heat Consuming Devices. During the installation of a boiler a safe distance between the boiler and any building materials must be at least 200 mm. The same safe distance is also required for a smoke flue located near inflammable materials of the B, C1, and C2 Combustibility Classes (for Combustibility Classes please see Table 1).

If your boiler and the smoke flue are located near any inflammable materials with C3 Combustibility Class, the safe distance of 200 mm must necessarily be doubled!

The safe distance of 200 mm must also be doubled if the Combustibility Class of any materials located near your boiler and/or your smoke flue is unknown.

The safe distance may be reduced to half of the normal safe distance (100 mm) when using a thermally insulating shield of a minimum thickness of 5 mm. Such shield must be located 25 mm from the inflammable material it is intended to protect. The cover shield or a thermal barrier must extend at least 150 mm beyond either of the lateral edges of a boiler (together with the smoke flue outlet) and at least 300 mm beyond the upper edge of a boiler.

If your boiler is placed on the floor that is made of inflammable material(s), such floor must be shielded with a thermally insulating fireproof board extending at least 300 mm beyond the ground plan on the firetending side and at least 100 mm beyond the ground plan on all other sides. For this purpose, any incombustible, fireproof, thermally insulating materials can be used.

Combustibility Class of Building Materials and Products	Building Materials and Products Falling within the Combustibility Class
A – incombustible	granite, sandstone, concrete, bricks, ceramic tiles, mortar, fire retardant plasters etc.
B – not easily combustible	wood-wool slabs, isomin, lignostone, slabs of basalt wool, glass fiber slabs, novodur etc.
C1 – hardly combustible	deciduous hard wood, hobrex, laminated paper, laminated plastic sheets (Formica) etc.
C2 – medium combustible	coniferous wood, wood-chips, wood chipboards, particle boards etc.
C3 – easily combustible	Fiberboards (hardboard and the like), polyurethane, polystyrene, polyethylene

Smoke Flue

A smoke flue outlet must run into a chimney flue. A boiler must not be connected to a chimney directly/immediately. A smoke flue should be as short as reasonably possible, but in no instance longer than 1 m, without any additional heating surface, and should ascend towards the chimney. It must be mechanically solid, fixed, thoroughly tight against leakage of combustion products, and should enable cleaning of its internal surfaces.

A smoke flue must not run through someone else's residential or non-residential units or facilities.

The internal cross section of a smoke flue must not be greater than that of the chimney and must not narrow towards the chimney. No bends should be included in a smoke flue.

12. Type of Environment

A boiler can be safely operated in a "normal NM – 1 environment" that is specified in Slovak Technical Standard STN 332000-3.

CAUTION: A boiler must be installed in a boiler room where a suitable supply of combustion air is provided. A boiler must under no circumstances be located within a residential space.

Under any circumstances which might possibly give rise to the danger of penetrating a residential space with inflammable gases or vapors or during the course of any works that may involve the danger of fire or explosion, a boiler must be put out of operation in a timely manner, before any such danger occurs. (e.g. bonding of floor coverings, PVC and the like).

No objects consisting of inflammable materials must be put onto a boiler or within a distance less than the safe distance.

13. Operation and Supervision

Any personnel operating a boiler are required to follow this Operation and Maintenance Manual. No interventions in a boiler which might endanger the health and/or safety of the operator(s) or any other persons sharing the given residential space/area are permitted.

A boiler may only be operated by individuals over the age of 18 who are thoroughly familiar with this Operation and Maintenance Manual.

No children should be allowed to remain within a close distance to a boiler that is currently under operation.

When operating a solid fuel fired boiler no inflammable liquids are permitted to be used for firing up. Increasing in any manner a boiler's output capacity during operation is prohibited as well.

In the course of normal operation, a boiler must be controlled by operating personnel.

A user is only allowed to perform such repairs that involve replacement of standard spare parts (such as fireproof concrete insulation bricks and the like). No user is allowed to interfere with the design and/or electric wiring of a boiler.

14. Recommended Accessories for MA gasifying boilers

1) The DUOMIX mixing valve is an appropriate element to regulate a central heating system. It ensures that the heating water input temperature in a boiler does not drop below 60 °C (140 °F). (Also other types of devices capable of ensuring that the return water temperature does not drop below 60 °C (140 °F) may be applied – e.g. a thermoregulation valve).

2) Circulating pump with thermostat or

3) Laddomat or similar system.

15. Spare Parts

Fireproof tile blocks (5, 10); Fan (4). There are additional spare parts available (should be consulted with your local distributor).

BOILER BASIC DRAWING(more types):

- 1 Boiler body (shell)
- 2 Door to add fuel (upper door)
- 3 Door to remove ash (lower door)
- 4 Exhaust fan
- 5 Bottom of combustion space(refractory concrete)
- 6 Control panel
- 7 Air flap valve
- 8 Secondary air inlet
- 9 Primary air inlet
- 10 Ceramics nozzle
- 11 Firing flap valve
- 12 Primary air inlet duct
- 13 Clean-out cover- 14 Smoke flue outlet
- 15 Firing valve's draw rod
- 16 Fuse
- 17 Chimney sensor (flue gas temperature sensor)
- 18 Ceramic "U" tube
- 19 Hot water outlet (DN 40, G1,1/2'')
- 20 Cold water intlet (DN 40, G1,1/2'')
- 21 Inlet opening
- 22 Thermal insulation
- 23 Colling exchanger
- 24 Tube heat exchanger
- 25 Turbulator (air-brake valve)
- 26 Front cover panel

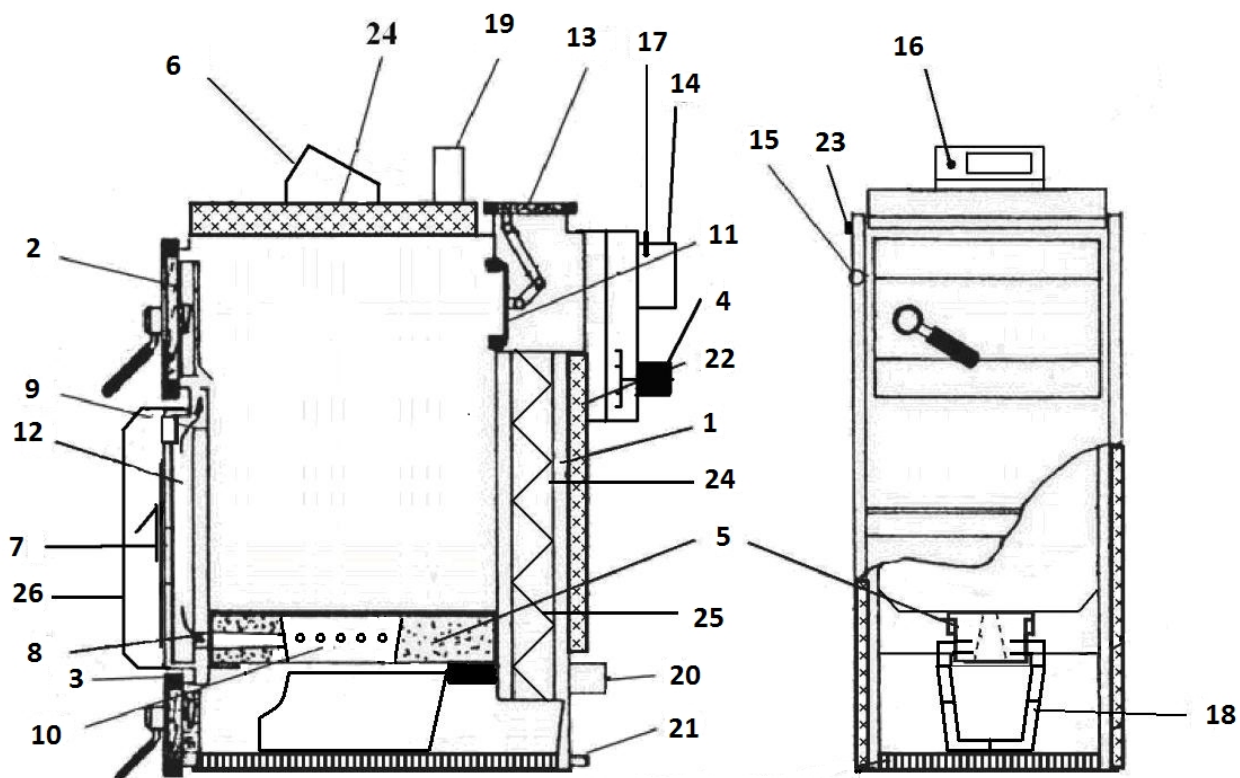

16. Boiler Installation

Boilers are typically supplied to customers equipped with basic boiler regulation. The regulation ensures the required heating water output temperature of 75 to 90° C. It does not cover the control of mixing valves and pumps. Each of the pumps within the system must be operated by a separate, independent thermostat in order that the reverse operation is not overcooled (i.e. the reverse temperature should not drop below 60°C). If a boiler is installed without a heat storage unit or without an equalizing reservoir, any pump located within the heated spaces must be operated (switched on and off) by an independent thermostat or by means of electronic regulation so that such pump only runs when the boiler circuit's pump is running. If you use two thermostats (each of them to operate a single pump), then you should set the boiler pump's switch-on temperature to 75 °C and the switch-on temperature for the heating circuit's pump to 80 °C. At least one pump need to be equipped with filter.

The selection of the required temperature for the water running into the heated building (spaces) is done using a 3-way or 4-way mixing valve. The 3-way valve itself does not provide boiler's only-hot-water security. Such mixing valve can either be operated manually or through an electronic regulating device that will provide a more comfortable and more economic operation of the boiler. Any related electrical wiring and devices must be done/installed by authorized professional personnel in accordance with the STN EN standard.

Protecting your boiler from low-temperature corrosion.

The boiler is required to be installed/connected with a Laddomat or thermoregulating valve. This way of connection provides the thermal separation of the boiler and the heating circuits so that it can ensure a minimum temperature of 60 °C for the return water running back to the boiler. The output water temperature must be kept constant within the range from 75 to 90 °C. Under normal operating conditions, the temperature of the combustion products must never fall below the minimum of 110 °C. A low temperature of the combustion products results in the condensation of tars and acids although the output water temperature is kept within the range of 75 - 90 °C and the return water temperature is kept at 60 degrees centigrade. Such conditions may occur, for instance, during the heating of hot tap water in the summer seasons or when only a portion of a building is being heated. In such cases we recommend that the boiler be connected with heat storage units (tanks) or lighting the boiler on a daily basis. The boiler must not be operating for a long time period below 60% of its maximum output capacity.

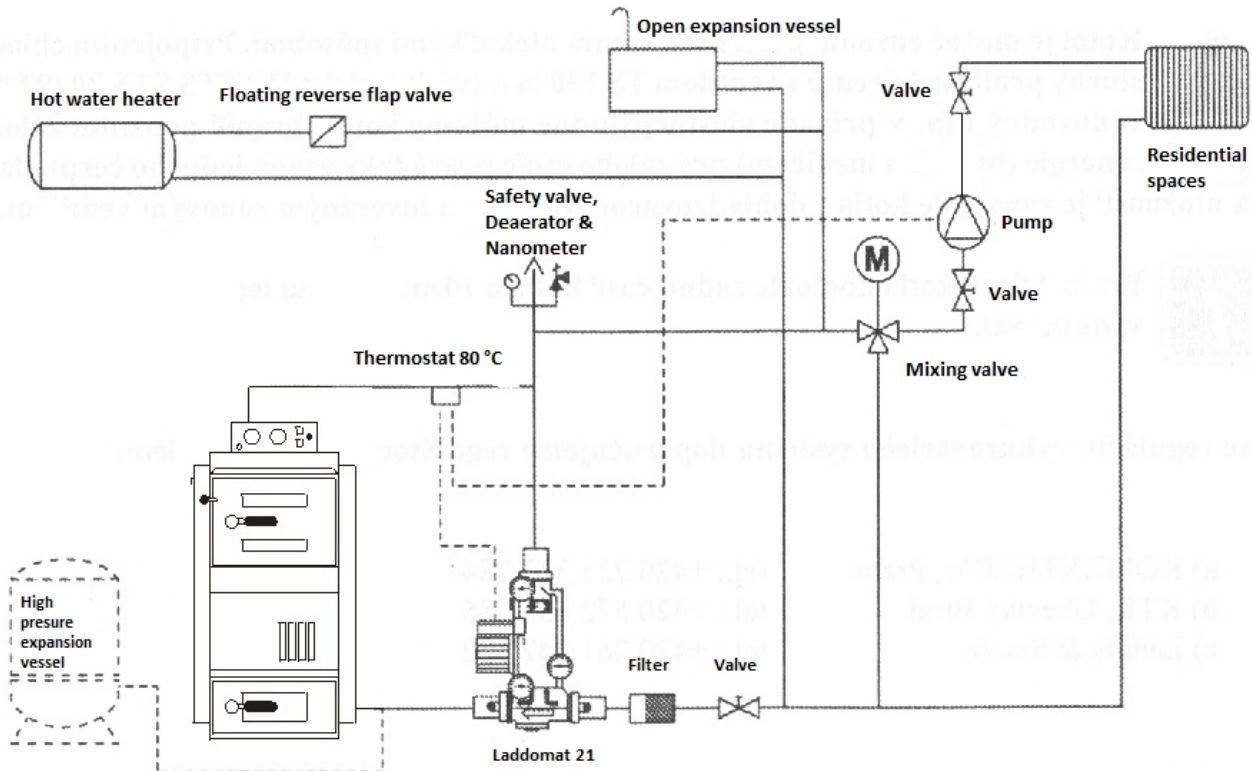

Boiler Installation/Connection with Laddomat

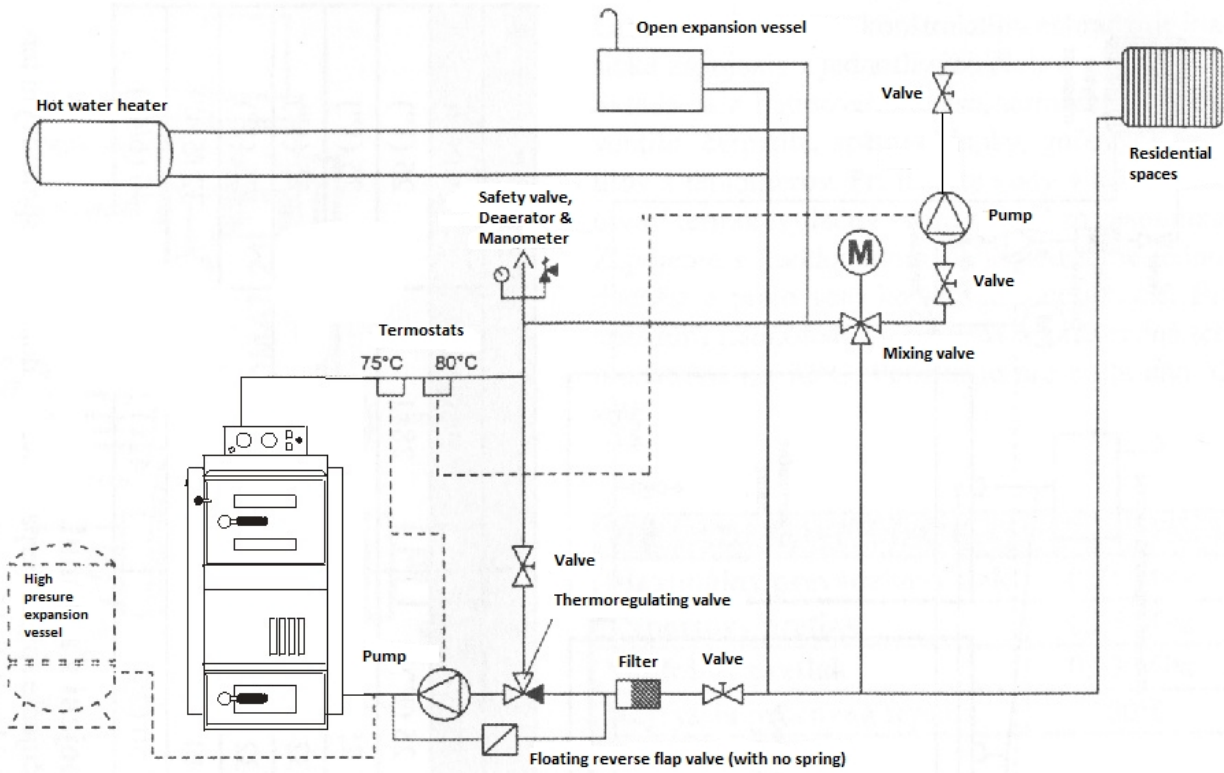

Boiler Installation/Connection with a Thermoregulating Valve

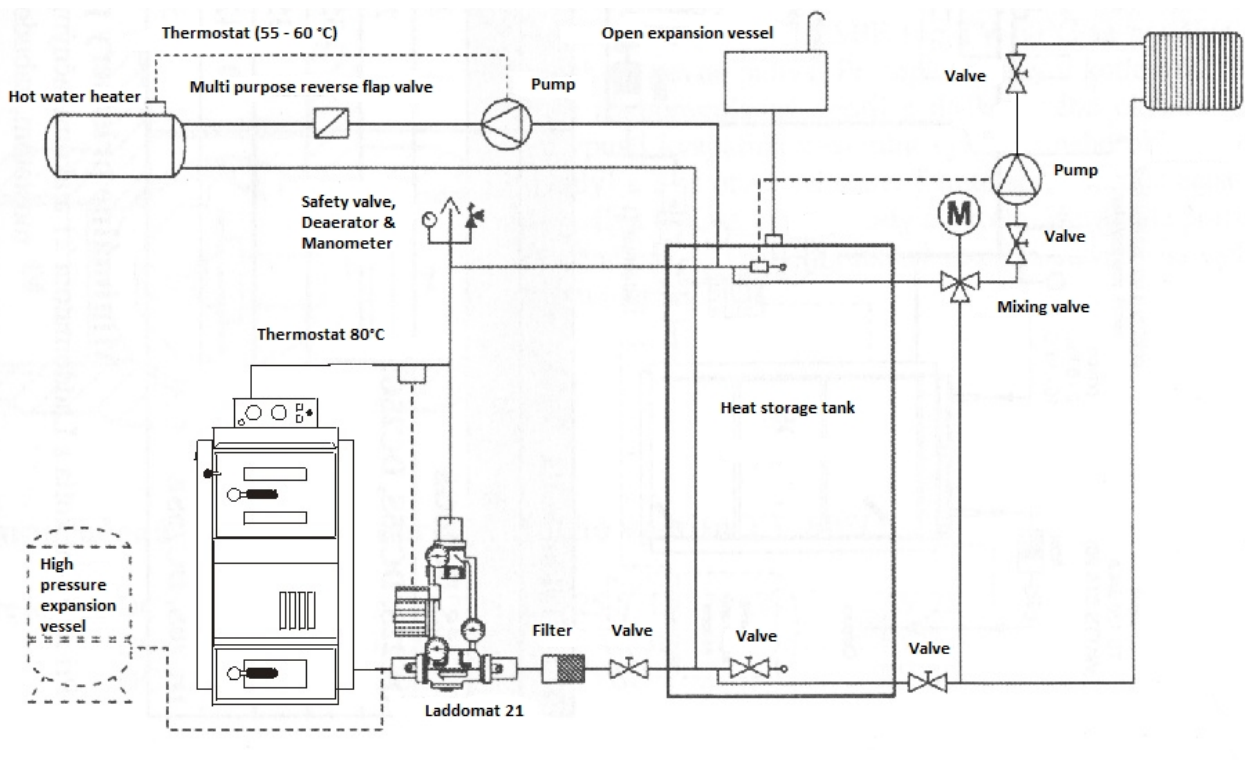

Boiler Installation/Connection with a Heat Storage Tank

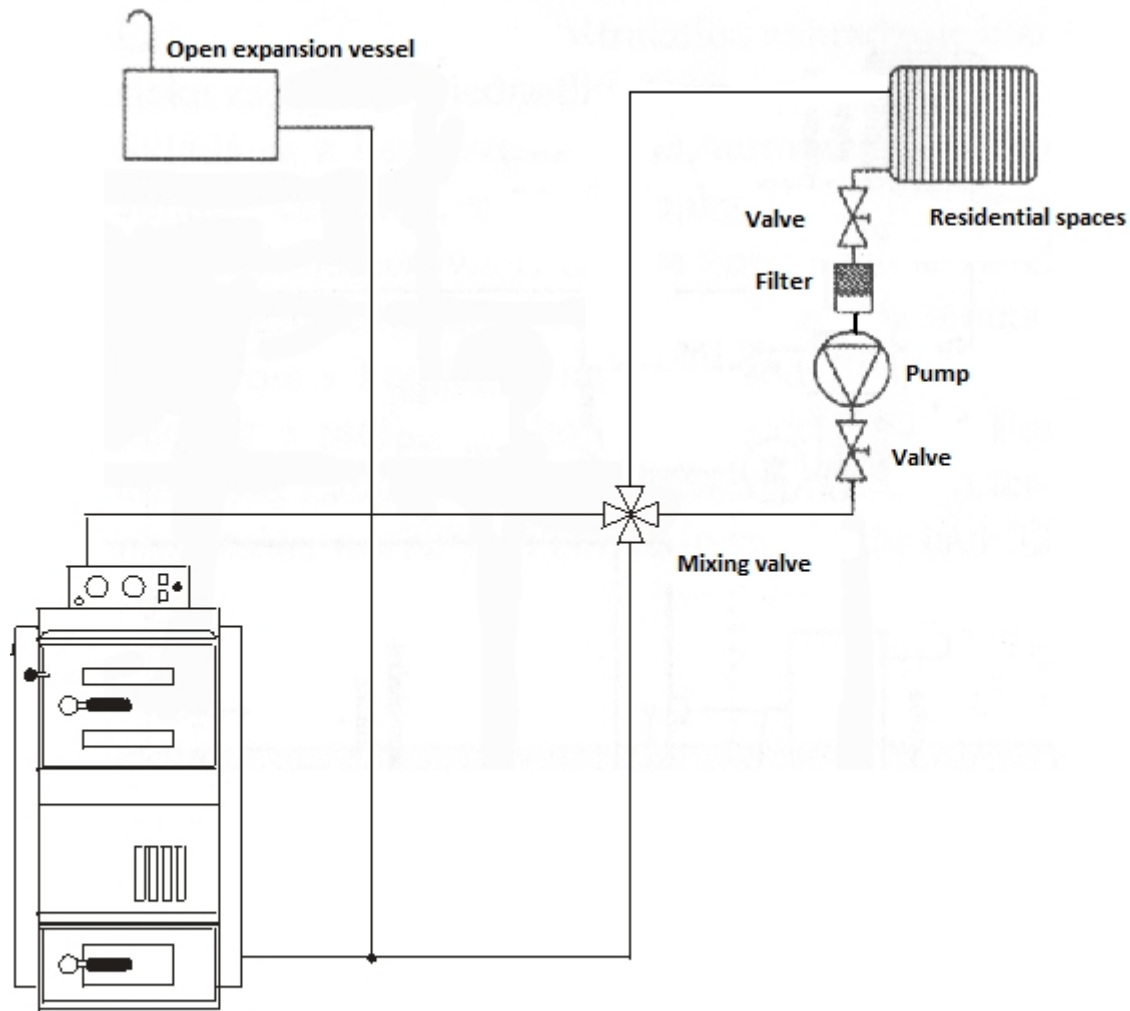

Boiler Installation/Connection with a 4-way valve

Operation of the system with heat storage units (tanks)

After the boiler is fired up and is operated at full capacity, it will heat the water in the storage tank to a temperature of about 80-90 °C (which may take from 2 to 4 fuel loads). Then the boiler should be left to go out. Thereafter, heat is only taken from the storage tank using a 3-way valve, which will last for a period depending on the volume of the storage tank and the outdoor temperature.

Recommended heat storage unit sizes:

Boiler Type	MA 15	MA 20	MA 25	MA 31	MA 40	MA 49	MA 80
Capacity (kW)	15	20	25	31	40	49	80
Volume (l)	1000	1000-1500	1500-2000	2000-2500	3000-3500	3500-4000	4000-5000

The above listed heat storage units must be sufficiently thermally insulated.

Advantages of the heat storage unit use:

- up to 20 - 30 % lower fuel consumption – the boiler operates at full output capacity giving an optimum heating coefficient of performance.
- high lifespan of both the boiler and the chimney – minimum tar and acid production
- comfortable and convenient way of heating and an ideal fuel burning conditions.

17. Protecting the Boiler against Accidental Overheating

There are several methods that can be used to secure your boiler against unwanted overheating. You can either connect a cooling heat exchanger protecting the system from overheating by using Danfoss BVTs, Honeywell TS 130 or WATTS STS 20 connected to water supply piping. In the event you use your own well, you can protect your boiler using a backup electric power source to sustain the operation of at least one pump. Another option is to connect the boiler together with a cooling tank and an inverse valve.

VERSION Nr. 1:

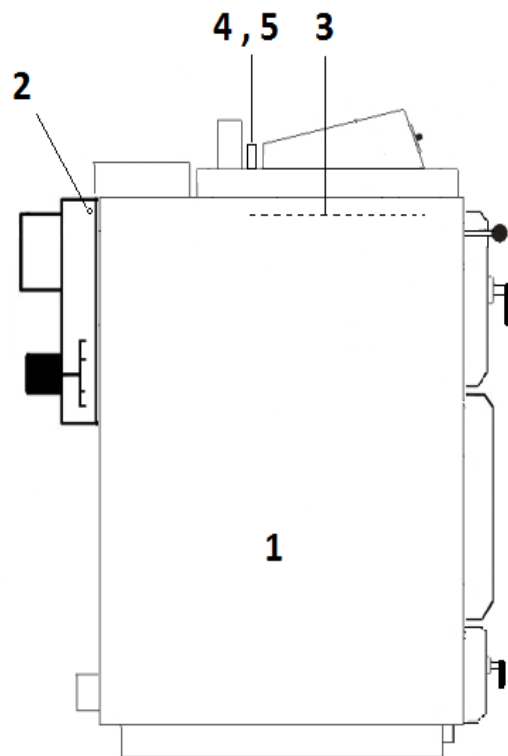

Figure: Cooling Pipes, Valves and Fittings Connection Scheme

- 1) Boiler
- 2) Reservoir + temperature sensor
- 3) Cooling heat exchanger in the boiler
- 4) Cooling water output
- 5) Cooling water input

VERSION Nr. 2:

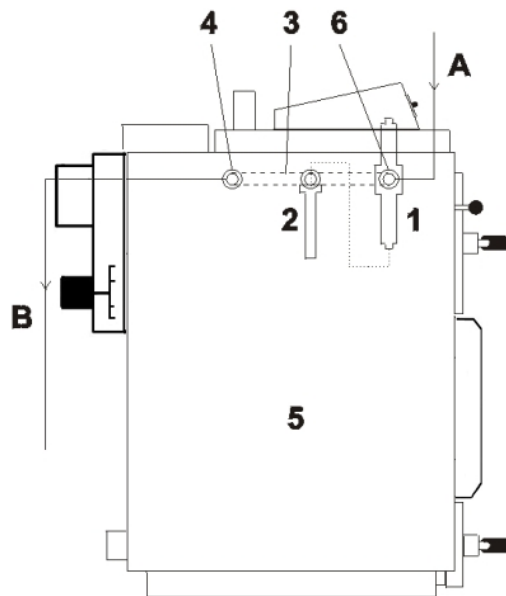

Figure: Cooling Pipes, Valves and Fittings Connection Scheme

- 1) Safety relief valve
 - 2) Reservoir + temperature sensor
 - 3) Cooling heat exchanger in the boiler
 - 4) Cooling water output
 - 5) Boiler
 - 6) Cooling water input
- A - Cooling water inlet, 2 - 6 bar, temperature of 10-15 °C
B - Drain

CAUTION!

The cooling heat exchanger protecting the system from overheating must not be used for any other purposes except the protection of the boiler from overheating.

Be sure to complete the installation of both the valve and the temperature sensor before you fill up the boiler with heating water!!!

The Danfoss BVTS, Honeywell TS 130 or the WATTS STS 20 valve, the sensor of which is located in the lateral part of the boiler, is intended to protect the boiler from overheating by filling the cooler with cold tap water at any time when the temperature of the water inside the boiler increases above 95 °C. The cooling water will subsequently be discharged into the drain. In the event that a reverse flap valve is placed in the cooler's inlet to prevent possible water backflow under reduced pressure conditions in water supply pipes, the connection to the cooling heat exchanger must be secured with a 6-10 bar safety valve or with an expansion vessel of at least 4 liters in volume.

18. CONTROL UNIT ST 81 zPID

Service manual for CONTROL UNIT ST 81 zPID

For MAGA WOOD-FIRED GASIFYING BOILER

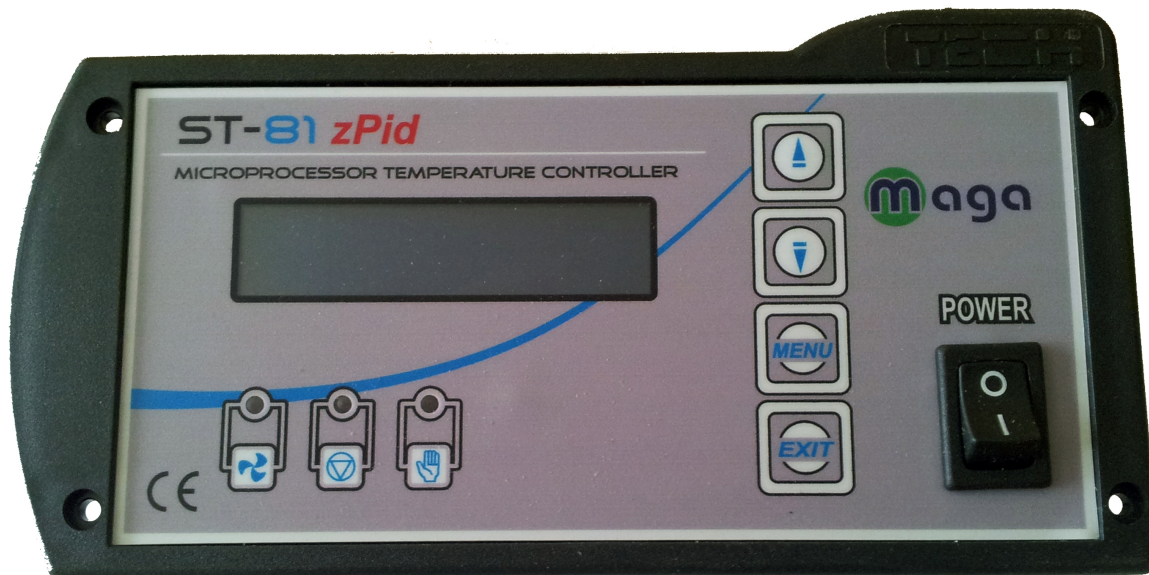

The control unit ST 81 zPID is intelligent system, that operates the maximum capacity output of the Boiler regarding the information received from the chimney sensor.

The control unit controls the temperature of flue gas and ensures minimal oscillation of the outlet water temperature. By the PID algorithm there is up to 13 % save in the fuel consumption. There are no not controlled heat losses to the chimney.

Technical Specifications/Parameters: _

Power Supply/Voltage	230 V / 50 Hz	+/-10 %
Power Input	4 W	
Operating Temperature	10 – 50 ° C	
Circular Pump Maximum Output Load	1 A	
Fan Maximum Output Load	1 A	
Temperature Measuring Range	0 through 95 ° C	
Temperature Adjustment Range	40 through 90 ° C	
Sensor Thermal Resistance	– 25 through 100 ° C	
Fuse	3,15 A	

END USER SETTINGS:

Turning the Control Unit (CU) On/Off: Use the Power button to switch the CU ON (I) or OFF (O).

In addition to the LCD display, there are three pilot lights located on the front of the CU to indicate the operations:



- fan



- pump



- fire up

Functions of the CU:

This section contains information on the functions provided by the regulator unit, the methods of its adjustment, and how to view the menu.

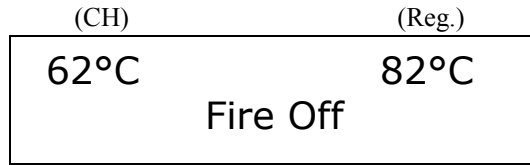

Initial Screen







The Boiler is not operating.

Under normal operation mode the regulator's LCD display will show the *initial screen* where the following information can be read:

- **Fire Off**
- **Boiler Temperature** **Boiler**
- **Set Temperature (manually entered)** **Reg.**

The buttons  and  located on this screen (panel) allow quick changing of the *manually set temperature*.

By pressing the  push-button, a user will transfer to the first-level menu. The first two lines of the menu will appear on the

screen. In each of the menus you can navigate using the  and  arrow buttons. Pressing the  button will take you to another submenu, or launch the currently displayed option.

By pressing the  push-button, a user will switch back to the initial menu.

Functions

Pressing the  button once will take you to the first-level menu.

Ignition: By pressing the  button again, you will turn on the "firing boiler" function. The exhaust fan will smoothly increase the speed of rotation, up to the maximum speed. Upon reaching the preset temperature, the "**fire up**" function will end and switch to automatic mode - please see the Service Parameters.

Manual mode: When operating under the manual control mode, the following components/functions can be switched on or off

using the  push button:

- 1) Fan Output (range from 0-100%)
- 2) Fan
- 3) Pump
- 4) Alarm

CH Pump Temp: Temperature setting for main heating system circulating pump. Range is from 30°C to 60°C.

Alarm sound: Option to silence the audio alarm.

Language: The control unit allows changes of menu language unlimited times.

Default settings: Once the "Default settings" item is set to YES, all settings will be reset to the default values set by the manufacturer.

Boiler Protection and Errors:

In order to ensure the safest possible and failure-free operation, the regulator is equipped with a variety of protective elements. In the event of malfunction you will hear a warning sound (ALARM – if not silenced) and the display will show the applicable error information. Alarm sound could be silenced from menu.

CH guage damaged If this condition occurs, please call technician for service or part replacement.

CH Temperature too high If this condition occurs, allow more heat to be conducted away from the boiler. Alarm temperature is above 95 °C.

Ignition not succeeded Please check fuel bin condition and operation of fan.

After the cause of such alarm has been remedied and the regulator reset, the boiler will operate in its normal mode again.

In case of CU malfunction please check the fuse and power to the unit. If both of these are restored and the unit is still not turning On or is not functioning properly call nearest service center for replacement.

Thermal Protection: Thermal protection is ensured through an auxiliary bimetallic mini sensor (located near the boiler temperature sensor) that switches the fan off whenever the temperature rises above a predetermined threshold. The temperature threshold for the alarm to be activated is 95 °C. This feature prevents the boiler from overheating and the regulator from being damaged. This type of thermal protection (through a bimetallic strip) ensures that the system returns to its initial condition **automatically**.

Fuse : Control Unit circuit protection is provided by a 3,15 A fusible safety plug.

CAUTION: Do not use fuses with higher current values. Placing a fuse with an excessive ampere value may cause your boiler's control panel to be damaged.

Fan and exhaust temperature status:



In the main menu hold the button for 2 seconds.

Following information will show.

- CH screen**
- Chimney screen**
- Fitter parameters**

CH screen:

62°C	85°C
Boiler	Req.

Chimney screen: display will show boiler temp., exhaust gases temp. & fan RPM

62°C	120°C	56%
Boiler	Fumes	Fan

How to Connect the CU:

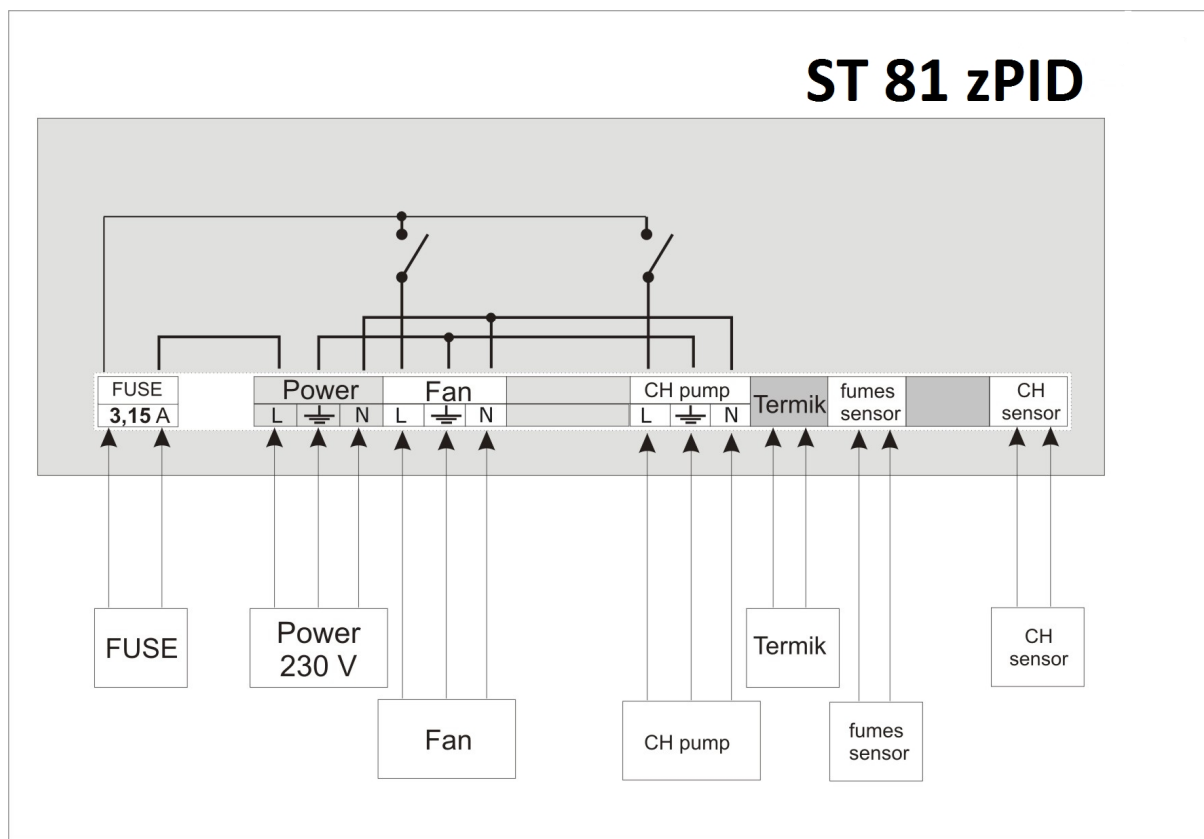

- Fuse: 3.15 Amp
- Power: 230 Volts / 50Hz
- Fan: 230 Volt / 1 Amp max.
- CH pump: circulating pump 230 Volt / 1 Amp max.
- Termik: safety thermostat
- Fumes sensor: chimney temperature sensor
- CH sensor: boiler temperature sensor

Indication for Power, Fan, CH pump:

- L** Power (Brown)
- PE** Protection Earth (Yellow – Green)
- N** Neutral (Blue)

Default settings:

Reg. temperature	85°C
CH pump temp	60°C
Max chimney	220 °C
Min fan	35
Max fan	170
Sustain work	8 s
Sustain pause	15 min
Sustain power	60 %

**LETTER OF GUARANTEE
of the wood-fired hot water gasifying boiler**

This letter of guarantee substitutes certificate of quality and integrity of the product. Producer confirms that the boiler meets requirements of demanded quality, is complete in an extent specified by documentation and is in accordance with STN EN 303-5.

Product:.....

Serial number:.....

Production date:

Stamp and signature of the producer

Date of sale:

Stamp and signature of the seller

Date of putting into operation:

Stamp and signature

Letter of guarantee is not valid unless properly filled in and confirmed by the seller or when rewritten!
(in this case guarantee expires)

Customer is obliged to control all the documents!

By buying the product customer fully agrees with all conditions for guarantee and complaints of the product.

Instructions for purchaser - conditions for guarantee and complaints form inseparable part of the letter of guarantee.

Instructions for purchaser - conditions for guarantee and complaints:

- 1) Complaints of completeness of the delivery can be exercised in accordance with the Commercial Code and Civil Code at the supplier.
- 2) Producer gives a guarantee on the product for the period of 24 months starting on a day of sale to the end customer whereby the temperature of the return pipe by operation must be at least 60 °C. Guarantee period begins by date of sale regardless of the time when the product was put into operation.
- 3) Guarantee does not apply to failures that were caused:
By not abiding by the manual and instructions for use and maintenance of the boiler, inappropriate maintenance and operation or by using the product for other purposes than intended under normal conditions, by low-temperature corrosion of the boiler, wrong or unprofessional manipulation or by burning unauthorized fuel. It does not apply to failures caused by using components other than recommended by the producer or the supplier as well as repairs and modifications performed by person other than authorized by the producer or the supplier. Furthermore it does not apply to failures caused by accidental or deliberate penetration of liquids, insects, animals or other objects into the interior of the product.
- 4) **In case of failure of a component, this component will be repaired or changed within a guarantee period after the damaged component has been delivered with covered cost for the transport by customer.**
- 5) Guarantee is valid if the product is being used as described and determined in the letter of guarantee. In case the relevant instructions are not fulfilled, guarantee will fail. This is valid also for damages caused during transport that has not been provided by our company's means by our own vehicle and our drivers. Therefore it is necessary to control the product and check possible imperfections when receiving the product or report the failures to the seller when receiving the product.
- 6) Guarantee expires in case of failures caused by unprofessional plugging (by not keeping to the connection mentioned in the manual), in case of overloading as a result of high voltage or voltage change or when using fuel other than prescribed for this type of product.
Guarantee does not include any materials that are subject to common wear and tear: sealing and packing rope, fire concrete block and filling and sibril filling.
Guarantee will not be granted and accepted in case the customer does not fulfil agreed account terms in due date to the seller. Minor variations in colour, enamel or dimension do not represent a reason for complaint. **Transport of a service technician does not fall within guarantee repairs and the customer endows the cost to full extent.**
- 7) Possible complaints of any sort must be sent by the end customer **in written form** within three workdays since the day of discovery of failure by post, fax or the electronic post and the supplier must be given all relevant information; report about the emerged failure sent by other means than by post has to be confirmed by a letter sent within three days at most. Authorized person is obliged to prove to the supplier the occurrence of damage caused by the failure of the product without postponement - three workdays since the request from the side of the supplier at latest. Producer is obliged to take stand in written form within 30 days from the announcement of the complaint and in case of accepting the complaint remove the failure.
Costs for ungrounded complaints, damages caused by the user by not abiding by the manual, unprofessionally performed assemblage, that may result in wrong operation of the product or reduced performance are covered by the user of the product to full extent.
Rights of the responsibility for the failures of the product that fall under the guarantee period lapse when not enforced during the guarantee period.
Customer has been acquainted with the operation of the boiler by purchase of the product.
Producing company rejects any responsibility for material or property damage either direct or indirect including consequent damages. Claims from damages of the product do not affect claims for damages caused by casual relationship with the damage of the product.
Producer reserves the right of change in innovation of the product that may not be included in this instruction.
In case of intervention into the wiring of the boiler by person other than authorized service technician or other professionally trained worker the guarantee expires.
The letter of customer must be duly filled in and sent to the producer or otherwise customer loses claim on the repair under guarantee.

Record of performed guarantee repairs

Record of performed repairs within guarantee period and after			
Date of the record	Performed activity	Organization (signature, stamp)	Signature of the customer



CONFORMITY DECLARATION

Issued according to § 12 section 3 letter a) of the law number 264/1999 of the code
a 97 / 23 EC

We MAGA Ltd.

S. KOLLÁRA 86
ČERENČANY
979 01 RIMAVSKÁ SOBOTA
SLOVAKIA
IČ DPH: SK 2020075904

Declare to our full responsibility that the mentioned products meet the requirements of technical regulations, that the products are safe to use when conditions for their use are met and that we took all measures to secure accordance of the undermentioned products with technical documentation and with demands of governmental orders.

Product : WOOD-FIRED HOT WATER BOILER

Type : MA 15 , MA 20, MA 25 , MA 31, MA 40, MA 49, MA 80

Producer : MAGA s.r.o.
S. KOLLÁRA 86
ČERENČANY
979 01 RIMAVSKÁ SOBOTA
SLOVAKIA

Above mentioned products are compatible with the following standards:

EN 303-5:2001, STN 92 0300:1997
EN 55014-1:2000+A1+A2, EN 55014-2:1997+A1, EN 61000-3-2:2000,
EN 61000-3-3:1995+A1, EN 60335-1:2002+A1+A11, EN 50165:1997+A1

Subsidiary information: REPORT OF THE INITIAL TESTS OF THE BUILDING PRODUCT

No S 03/09/0009/4501/SC/2	date 02. 11.2009
Registration No: UK 2692028 01	
Report No: 28202058 001	date 17.4.2006
Registration No: UK 2692029 01	
Report No: 28202091 001	date 17.4.2006

Certificates issued by: Technický skúšobný ústav Piešťany
TÜV Rheinland

Place of issuing the declaration: Čerenčany Name: Ing. Miroslav Müller

Date of issuing: 22.06.2010

Position : director

Signature:

MAGA s.r.o.
S. Kollára 86, Čerenčany
979 01 RIMAVSKÁ SOBOTA